





■ Relay Classification

Model	Mounting	Enclosure Ratings	Features
G4W 	Discrete	Unsealed	Designed for manual soldering
G2R 		Flux protection	Design inhibits flux intrusion into the casing from the terminals during soldering.
G6A 		Fully sealed	Sealed resin casings and covers, limiting damage from corrosive atmospheres.
G6S 	Surface mounting		Surface mounting relays permit automatic reflow soldering.

■ Construction

SEALING

Unsealed Relays

Relays of this type are intended for manual soldering. No measures are taken against penetration of flux and cleaning solvent into the relay. This type of relay cannot be immersion-cleaned.



Flux-protection Relays

Special design construction prevents flux from penetrating into the relay housing, for example, due to capillary action up the terminals when the relay is soldered onto a PCB. This type of relay also cannot be immersion-cleaned.

Fully Sealed Relays

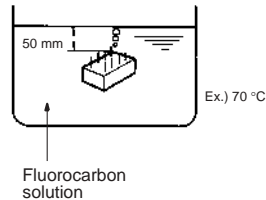
Fully sealing prevents not only flux, but also cleaning solvent from penetrating into the relay housing. Therefore, this type of relay can be immersion-cleaned. Relays are each tested before being shipped. The relay is immersed in fluorocarbon solution for 1 minute, at a temperature of 70°C +5°C/-0°C, to see if gases escape from the relay. The following figure illustrates the test conditions.

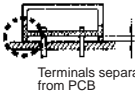

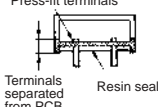
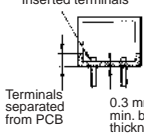
Classification	Unsealed		Flux protection	
	Construction	Contacts located at upper part of relay case	Press-fit terminals	Inserted terminals
	 Terminals separated from PCB		 Terminals separated from PCB Resin seal	 Terminals separated from PCB 0.3 mm min. base thickness
Features	Terminals are separated from PCB surface when relay is mounted.	Contacts are positioned away from base.	Terminals are pressed into base.	Terminals are inserted into base 0.3 mm min. thick.
Automatic flux application	Poor	Poor	Good	Good
Automatic soldering	Poor	Poor	Good	Good
Automatic cleaning	Poor	Poor	Poor	Poor
Manual soldering	Good	Good	Good	Good
Penetration of dust	Fair		Fair	
Penetration of corrosive gas	Poor		Poor	

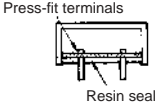
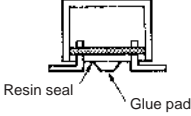
Classification	Fully Sealed	Surface Mounting
Construction	 <p>Press-fit terminals Resin seal</p>	 <p>Resin seal Glue pad</p>
Features	Terminals are separated from PCB surface when relay is mounted.	Terminal and base, as well as the base and casing, are sealed with adhesive; the L-shaped terminals and adhesive pads allow temporary fixing to the board.
Automatic flux application	Good	Good
Automatic soldering	Good	Good
Automatic cleaning	Good	Good
Manual soldering	Good	Good
Penetration of dust	Good	Good
Penetration of corrosive gas	Good	Good

■ Operation

SINGLE-SIDE STABLE RELAYS (STANDARD)

The contacts of this simple type of relay momentarily turn ON and OFF, depending on the excitement state of the coil.

**Terminal Arrangement/
Internal Connections
(Bottom View)**

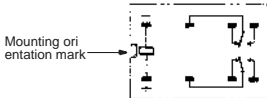

DOUBLE-WINDING, LATCHING RELAYS

This latching relay has two coils: set and reset. It can retain the ON or OFF states even when a pulsating voltage is supplied, or when the voltage is removed.

**Terminal Arrangement/
Internal Connections
(Bottom View)**

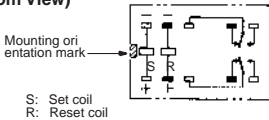

SINGLE-WINDING, LATCHING RELAYS

Unlike the double-winding latching relay, the single-winding latching relay has only one coil. This coil, however, serves as both the set and reset coils, depending on the polarity (direction) of current flow. When current flows through the coil in the forward direction, it functions as a set coil; when current flows through the coil in the reverse direction, it functions as a reset coil.

**Terminal Arrangement/
Internal Connections
(Bottom View)**

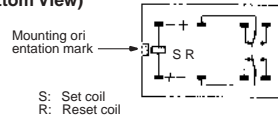

BUILT-IN DIODE

A diode is built into some relays, wired in parallel with the coil to absorb the counterelectromotive force (counter emf) generated by the coil.

BUILT-IN OPERATION INDICATOR

Some relays are provided with a light-emitting diode (LED), wired in parallel with the coil. This permits a fast-check of the relay's operating status.

■ **Contacts**

Contact ratings are generally indicated according to resistive loads and inductive loads ($\cos\phi = 0.4$ or $L/R = 7$ ms). Contact shape and material are also shown to guide the customer in selection of a model suitable for the intended load and required service life.

When used at extremely low loads, the failure rate differs according to the contact material and contact method, as shown in the figure. For example, in comparing a single contact point with a bifurcated contact point, the bifurcated contact model has higher parallel redundancy and will therefore exhibit a lower failure rate.

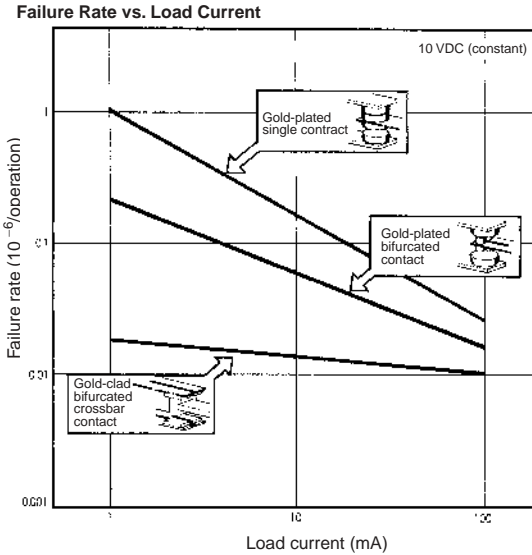

■ **Terminals**

STRAIGHT PCB TERMINALS

PCB terminals are normally straight.

Self-clinching (S-shaped) PCB Terminals

Some relays have terminals that are bent into an “S” shape. This secures the PCB relay to the PCB prior to soldering, helping the terminals stay in their holes and keeping the relay level.

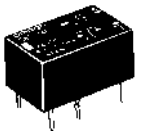

Terminal

Quick-connect Terminals



Plug-in Terminals

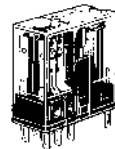

■ **Dimensions**

For miniature relays, the maximum dimensions and the average values (*) marked with an asterisk are provided to aid the customer in designing.

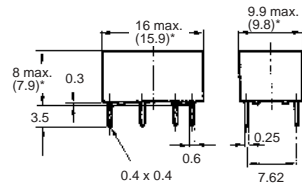

*Average value

MOUNTING ORIENTATION MARK

On the top of all OMRON relays is a mark indicating where the relay coil is located. Knowing the coil location aids in designing PCBs when spacing components. Also, pin orientation is easy to discern when automatic or hand-mounting relays.

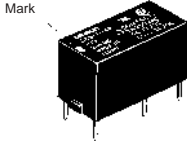

On dimensional drawings in all OMRON literature this mark is left-oriented. Mounting holes, terminal arrangements, and internal connections follow this alignment. The following two symbols are used to represent the orientation mark.

Drawing view	Bottom	Top
Detail	Mounting holes	Terminal arrangement/ internal connections
Symbol		
Example		

TERMINAL ARRANGEMENT/INTERNAL CONNECTIONS

Top View

If the terminal arrangement of a relay can be seen from above the PCB, the top view of the relay is provided in the Dimensions section of the catalog or data sheet.

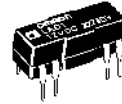

Bottom View

If the relay's terminals cannot be seen from above the PC board, as in this example, a bottom view is shown.

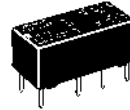

Rotation Direction to Bottom View

The bottom view shown in the catalog or data sheet is rotated in the direction indicated by the arrow, with the coil always on the left.

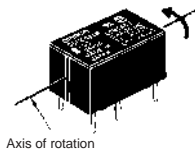

■ Moving Loop System

In the U.S.A., the National Association of Relay Manufacturers (NARM) in April 1984, awarded OMRON for monumental advances in relay technology, as embodied in the Moving Loop System.

This unique relay construction maximizes electrical and permanent magnet energy. A high-efficiency magnet adds to the magnetic flux of the relay coil, which also allows for tighter packing of relay parts. Relays having such a coil are known as "polarized relays." Details of construction are shown below.

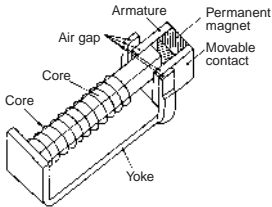

The moving loop design has similarities with polarized relays; however, the following two features make for a large performance distinction.

A permanent magnet is placed in the vicinity of the "working gaps." The flux energy of this permanent magnet complements that of the electrical coil. This increased efficiency enables the mechanism holding the contacts closed to ultimately switch larger loads, and at the same time reduces the power consumed by the coil.

The following diagram shows concentric lines of magnetic flux when the permanent magnet is placed near the working gap.

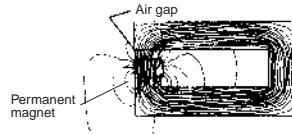

CONVENTIONAL RELAY COIL

The following diagram shows the lines of magnetic flux when the permanent magnet is placed away from the working gap. These lines of flux detract from the total strength of the coil.



When the switching voltage is removed from the coil, the collapse of the magnetic flux created by the permanent magnet and the electrical coil provides the force to return the relay contacts to the reset position. Note the flux path and magnet polarity in the illustration overleaf.

Operating Principle

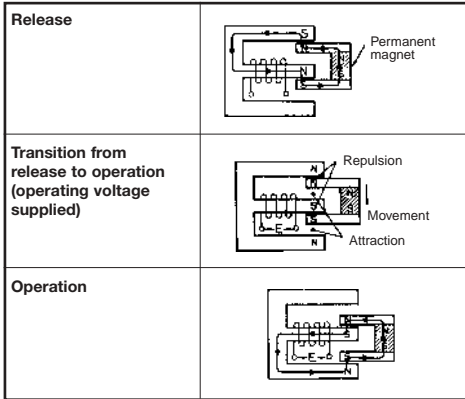

Super Moving Loop System

A very small high-sensitivity magnetic circuit is incorporated to further minimize the conventional moving loop system.

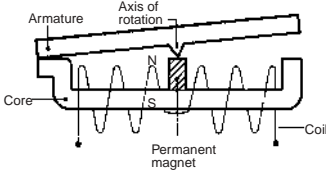

This magnetic circuit has the following features:

1. High-efficiency polarized magnetic circuit utilizes power of both attraction and repulsion.
2. Balanced armature system improves resistance to both vibration and impacts.
3. Ideal mechanism for a low-profile relay.

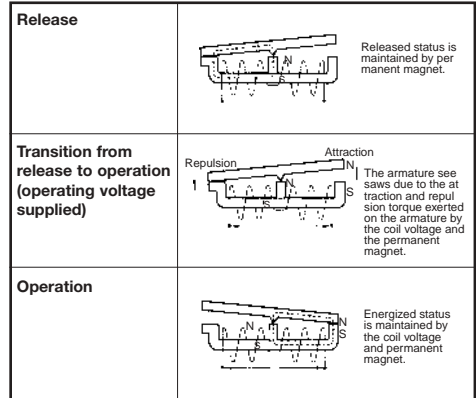

Note: The above applies to a latching relay.

■ Glossary

TERMS RELATED TO CONTACTS

Carry Current

The value of the current which can be continuously applied to the relay contacts without opening or closing them, and which allows the relay to stay within the permissible temperature rise.

Maximum Switching Current

A current which serves as a reference in determining the performance of the relay contacts. This value will never exceed the current flow. When using a relay, do not exceed this value.

Contact Form

OMRON uses the following relay terminology for the various polarity and switch configurations.

- SPST-NO (Single-pole, single-throw, normally open)
- SPST-NC (Single-pole, single-throw, normally close)
- SPDT (or changeover contact) (single-pole, double-throw)
- DPDT (Double-pole, double-throw)

Contact Symbols

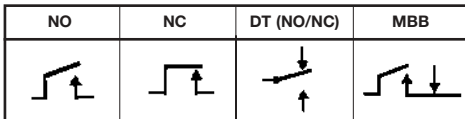

Make-before-break (MBB) Contact

A contact arrangement in which part of the switching section is shared between both an NO and NC contact. When the relay operates or releases, the contact that closes the circuit operates before the contact that opens the circuit releases. Thus both contacts are closed momentarily at the same time.

Contact Resistance

The total resistance of the conductor, as well as specific resistivities such as of the armature and terminal, and the resistance of the contacts. This value is determined by measuring the voltage drop across the contacts by applying test currents as shown in the table below.

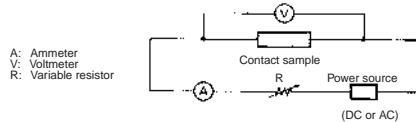

Test Current

Rated current or switching current	Test current (mA)
Less than 0.01	1
0.01 or higher but less than 0.1	10
0.1 or higher but less than 1	100
1 or higher	1,000

To measure the contact resistance, a milliohm-meter can also be used, although the accuracy drops slightly.

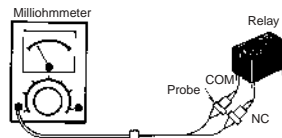

Maximum Switching Power

The maximum value of the load capacity which can be switched without problem. When using a relay, do not exceed this value. For example, when maximum switching voltage V_1 is known, maximum switching current I_1 can be obtained at the point of intersection on the characteristic curve "Maximum Switching Power" shown below. Conversely, maximum switching voltage V_1 can be obtained if I_1 is known.

Maximum switching current (I_1) = $\frac{\text{Max. switching power [W(VA)]}}{\text{Max. switching voltage (V1)}}$

Maximum switching voltage (V_1) = $\frac{\text{Max. switching power [W(VA)]}}{\text{Max. switching current (I1)}}$

For instance, if the maximum switching voltage = 40 V
 Maximum switching current = 2 A (see circled point on graph below.)

Maximum Switching Power

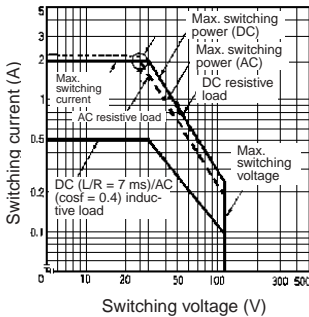

The life expectancy of the relay can be determined from the "Endurance" curve shown below, based on the rated switching current (I_1) obtained above. For instance, the electrical endurance at the obtained maximum switching current of 2 A is slightly over 300,000 operations (see circled point on graph below).

Endurance

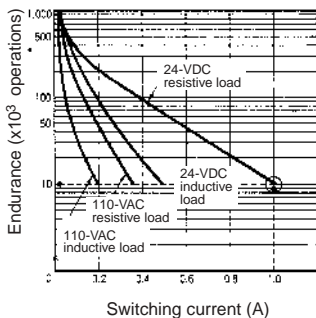

However, with a DC load, it may become difficult to break the circuit of 48 V or more due to arcing. Determine the suitability of the relay in actual usage testing.

The correlation between the contact ratings is shown in the following figure:

Maximum Switching Power

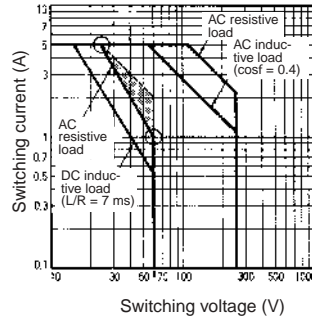

Failure Rate

The failure rate indicates the lower limit of switching capability of a relay as the reference value. Such minute load levels are found in microelectronic circuits. This value may vary, depending on operating frequency, operating conditions, expected reliability level of the relay, etc. It is always recommended to double-check relay suitability under actual load conditions.

In this catalog, the failure rate of each relay is indicated as a reference value. It indicates failure level at a reliability level of 60% (λ_{60}). $\lambda_{60} = 0.1 \times 10^{-6}$ /operation means that one failure is presumed to occur per 10,000,000 (ten million) operations at a reliability level of 60%.

Number of Poles

The number of contact circuits. See Contact Form for reference.

TERMS RELATED TO COILS

Rated Coil Voltage

A reference voltage applied to the coil when the relay is used under normal operating conditions.

Coil Symbols

Single-sided stable		Double-winding Latching		Single-winding latching
Polarised	Non-polarised	w/4 terminals	w/3 terminals	

Coil Resistance (Applicable to DC-switching Relays only)

The resistance of the coil is measured at a temperature of 23°C with a tolerance of ±10% unless otherwise specified. (The coil resistance of an AC-switching type relay may be given for reference when the coil inductance is specified.)

Hot Start

The ratings set forth in the catalog or data sheet are measured at a coil temperature of 23°C.

Maximum Voltage

The maximum value of the pulsating voltage fluctuations in the operating power supply to the relay coil.

Minimum Pulse Width

The minimum value of the pulsating voltage required to set and reset a latching relay at a temperature of 23°C.

Must Operate (Must Set) Voltage

The threshold value of a voltage at which a relay operates when the input voltage applied to the relay coil in the reset state is increased gradually.

Must Release (Must Reset) Voltage

The threshold value of a voltage at which a relay releases when the rated input voltage applied to the relay coil in the operating state is decreased gradually.

Power Consumption

The power (= rated voltage x rated current) consumed by the coil when the rated voltage is applied to it. A frequency of 60 Hz is assumed if the relay is intended for AC operation. The current flows through the coil when the rated voltage is applied to the coil at a temperature of 23°C. The tolerance is +15%/-20% unless otherwise specified.

TERMS RELATED TO ELECTRICAL CHARACTERISTICS

Dielectric Strength

The critical value which a dielectric can withstand without rupturing when a high-tension voltage is applied for 1 minute between the following points:

- Between coil and contact
- Between contacts of different polarity
- Between contacts of same polarity
- Between set coil and reset coil
- Between current-carrying metal parts and ground terminal

Note that normally a leakage current of 3 mA is detected; however, a leakage current of 1 mA to 10 mA may be detected on occasion.

Electrical Endurance

The life of a relay when it is switched at the rated operating frequency with the rated load applied to its contacts.

High-frequency Isolation (Applicable to High-frequency Relay only)

The degree of isolation of a high-frequency signal, which is equivalent to the insulation resistance of ordinary relays.

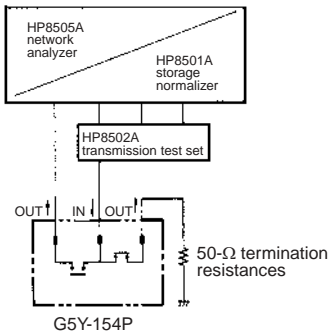

The following characteristics are measured with contacts unrelated to the measurement terminated at 50Ω, when a signal is applied from input terminal 11 to output terminal 8 or from input terminal 11 to output terminal 14 of the sample.

1. Isolation characteristics
2. Insertion loss characteristics
3. Return loss

The following conversion formula converts from return loss to VSWR.

$$VSWR = \frac{1 + 10^{-\frac{x}{20}}}{1 - 10^{-\frac{x}{20}}}$$

where,
x = return loss

High-frequency Switching Power (Applicable to High-frequency Relays Only)

The power of a high-frequency signal that can be switched.

High-frequency Transmitted Power (Applicable to High-frequency Relays Only)

The transmission capacity of a high-frequency signal.

Impulse Withstand Voltage

The critical value which the relay can withstand when the voltage surges momentarily due to lightning, switching an inductive load, etc. The surge waveform which has a pulse width of ±1.2 x 50 μs is shown below:

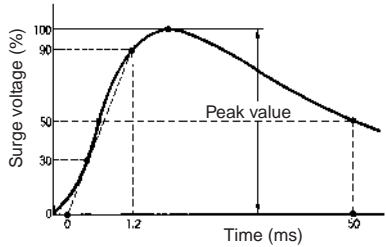

Insertion Loss (Applicable to High-frequency Relays Only)

The attenuation of a high-frequency signal in a transmission line and is equivalent to the contact resistance of ordinary relays.

Insulation Resistance

The resistance between an electric circuit such as the contacts and coil, and grounded, non-conductive metal parts such as the core, or the resistance between the contacts. The measured values are as follows:

Rated insulation voltage	Measured value
60 V max.	250 V
61 V min.	500 V

Maximum Operating Frequency

The frequency or intervals at which the relay continuously operates and releases, satisfying the rated mechanical and electrical endurance.

Mechanical Endurance

The life of a relay when it is switched at the rated operating frequency without the rated load.

Operate Bounce Time

The bounce time of the normally open (NO) contact of a relay when the rated coil voltage is applied to the relay coil at an ambient temperature of 23°C.

Operate Time

The time that elapses after power is applied to a relay coil until the NO contacts have closed, at an ambient temperature of 23°C. Bounce time is not included. For the relays having an operate time of less than 10 ms, the mean (reference) value of its operate time is specified as follows:

Operate time	5 ms max. (mean value: approx. 2.3 ms)
---------------------	--

Release Bounce Time

The bounce time of the normally closed (NC) contact of a relay when the coil is de-energized at an ambient temperature of 23°C.

Release Time

The time that elapses between the moment a relay coil is de-energized until the NC contacts have closed, at an ambient temperature of 23°C. (With a relay having SPST-NO or DPST-NO contacts, this is the time that elapses until the NO contacts have operated under the same condition.) Bounce time is not included. For the relays having an operate time of less than 10 ms, the mean (reference) value of its operate time is specified as follows:

Release time	5 ms max. (mean value: approx. 2.3 ms)
---------------------	--

Reset Time (Applicable to Latching Relays Only)

The time that elapses from the moment a relay coil is de-energized until the NC contacts have closed, at an ambient temperature of 23°C. (With a relay having SPST-NO contacts, this is the time that elapses until the NO contacts have operated under the same condition.) Bounce time is not included. For the relays having a reset time of less than 10 ms, the mean (reference) value of its reset time is specified as follows:

Reset time	5 ms max. (mean value: approx. 2.3 ms)
-------------------	--

Set Time

The time that elapses after power is applied to a relay coil until the NO contacts have closed, at an ambient temperature of 23°C. Bounce time is not included. For the relays having a set time of less than 10 ms, the mean (reference) value of its set time is specified as follows:

Reset time	5 ms max. (mean value: approx. 2.3 ms)
-------------------	--

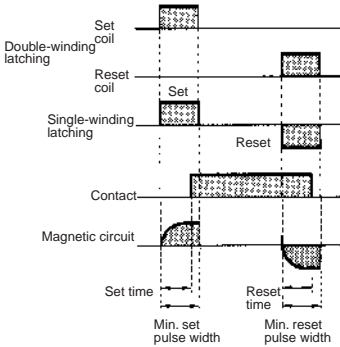

Shock Resistance

The shock resistance of a relay is divided into two categories: "Destruction" which quantifies the characteristic change of, or damage to, the relay due to considerably large shocks which may develop during the transportation or mounting of the relay, and "Malfunction" which quantifies the malfunction of the relay while it is in operation.

Stray Capacitance

The capacitance measured between terminals at an ambient temperature of 23°C and a frequency of 1 kHz.

VSWR (Applicable to High-frequency Relays Only)

Stands for voltage standing-wave ratio. The degree of reflected wave that is generated in the transmission line.

Vibration Resistance

The vibration resistance of a relay is divided into two categories: "Destruction" which quantifies the characteristic changes of, or damage to, the relay due to considerably large vibrations which may develop during the transportation or mounting of the relay, and "Malfunction" which quantifies the malfunction of the relay due to vibrations while it is in operation.

- a = 0.002fA
- where,
- a: Acceleration of vibration
- f: Frequency
- A: Double amplitude

Precautions

Basic Information

Before actually committing any component to a mass-production situation, OMRON strongly recommends situational testing, in as close to actual production situations as possible. One reason is to confirm that the product will still perform as expected after surviving the many handling and mounting processes involved in mass production. Also, even though OMRON relays are individually tested a number of times, and each meets strict requirements, a certain testing tolerance is permissible. When a high-precision product uses many components, each depends upon the rated performance thresholds of the other components. Thus, the overall performance tolerance may accumulate into undesirable levels. To avoid problems, always conduct tests under the actual application conditions.

GENERAL

To maintain the initial characteristics of a relay, exercise care that it is not dropped or mishandled. For the same reason, do not remove the case of the relay; otherwise, the characteristics may degrade. Avoid using the relay in an atmosphere containing sulphuric acid (SO₂), hydrogen sulphide (H₂S), or other corrosive gases. Do not continuously apply a voltage higher than the rated maximum voltage to the relay. Never try to operate the relay at a voltage and a current other than those rated.

If the relay is intended for DC operation, the coil has polarity. Connect the power source to the coil in the correct direction. Do not use the relay at temperatures higher than that specified in the catalog or data sheet.

The storage for the relay should be in room temperature and humidity.

COIL

1) AC-switching Relays

Generally, the coil temperature of the AC-switching relay rises higher than that of the DC-switching relay. This is because of resistance losses in the shading coil, eddy current losses in the magnetic circuit, and hysteresis losses. Moreover, a phenomenon known as "beat" may take place when the AC-switching relay operates on a voltage lower than that rated. For example, beat may occur if the relay's supply voltage drops. This often happens when a motor (which is to be controlled by the relay) is activated. This results in damage to the relay contacts by burning, contact weld, or disconnection of the self-holding circuit. Therefore, countermeasures must be taken to prevent fluctuation in the supply voltage.

One other point that requires attention is the "inrush current." When the relay operates, and the armature of the relay is released from the magnet, the impedance drops. As a result, a current much higher than that rated flows through the coil. This current is known as the inrush current. (When the armature is attracted to the magnet, however, the impedance rises, decreasing the inrush current to the rated level.) Adequate consideration must be given to the inrush current, along with the power consumption, especially when connecting several relays in parallel.

2) DC-switching Relays

This type of relay is often used as a so-called “marginal” relay that turns ON or OFF when the voltage or current reaches a critical value, as a substitute for a meter. However, if the relay is used in this way, its control output may fail to satisfy the ratings because the current applied to the coil gradually increases or decreases, slowing down the speed at which the contacts move. The coil resistance of the DC-switching relay changes by about 0.4% per degree C change in the ambient temperature. It also changes when the relay generates heat. This means that the must operate and must release voltages may increase as the temperature rises.

Coil switching voltage Source

If the supply voltage fluctuates, the relay will be caused to malfunction regardless of whether the fluctuation lasts for a long time or only for a moment.

For example, assume that a large-capacity solenoid, relay, motor, or heater is connected to the same power source as the relay, or that many relays are used at the same time. If the capacity of the power source is insufficient to operate these devices at the same time, the relay may not operate, because the supply voltage has dropped. Conversely, if a high voltage is applied to the relay (even after taking voltage drop into account), chances are that the full voltage will be applied. As a consequence, the relay’s coil will generate heat. Therefore, be sure 1) to use a power source with sufficient capacity and 2) that the supply voltage to the relay is within the rated must operate voltage range of the relay.

Minimum Must Operate Voltage

When the relay is used at a high temperature, or when the relay coil is continuously energized, the coil temperature rises and coil resistance increases. Consequently, the must operate voltage increases. This increase in the must operate voltage requires attention when determining the minimum must operate voltage are given below for reference when designing a power source appropriate for the relay.

Assuming a coil temperature rise of 10°C, the coil resistance will increase about 4%. The must operate voltage increases as follows:

- Rated values of Model LZN2 taken from catalog or data sheet
- Rated voltage: 12 VDC
- Coil resistance: 500Ω
- Must operate voltage: 80% max. of rated voltage at 23°C coil temperature

The rated current that flows through this relay can be obtained by dividing the rated voltage by the coil resistance. Hence,

$$12 \text{ VDC} \div 500\Omega = 24 \text{ mA}$$

However, the relay operates at 80% maximum of this rated current, i.e., 19.2 mA (= 24 mA x 0.8). Assuming that the coil temperature rises by 10°C, the coil resistance increases 4% to 520Ω (= 500Ω x 1.04). The voltage that must be applied to the relay to flow a switching current of 19.2 mA x 520Ω = 9.98 V. This voltage, which is at a coil temperature of 33°C (= 23°C + 10°C), is 83.2% of the rated voltage (= 9.98 V ÷ 12 V). As is evident from this, the must operate voltage increases when the coil temperature rises, in this example, 10°C from 23°C.

Coil Temperature vs. Must Operate/release Voltage (LZN)

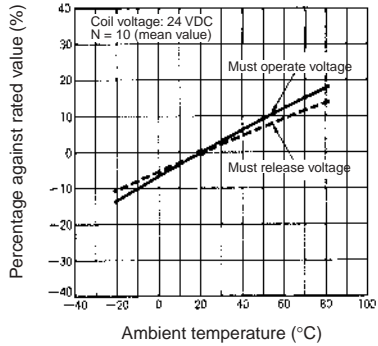

The minimum must operate voltage can be determined by this expression.

$$E_T > E \times \frac{E_{pv} + 5}{100} \times \left(\frac{T - T_a}{234.5 + T_a} + 1 \right) [V]$$

- where,
- E (V): Rated coil voltage
- E_{pv} (%): Must operate voltage
- T_a: Coil temperature for determining E_{pv} (20°C, unless otherwise specified)
- T (°C): Ambient operating temperature
- E_T (V): Minimum must operate voltage

Note: In the above expression, T is taken to be the result of energization of the coil, when the coil temperature is the same as the ambient temperature.

■ Coil Input

To guarantee accurate and stable relay operation, the first and foremost condition to be satisfied is the application of the rated voltage to the relay. Additionally, the rated voltage in light of the type of the power source, voltage fluctuation, and changes in coil resistance due to temperature rise. If a voltage higher than the rated maximum voltage is applied to the coil for a long time, layer short-circuiting and damage to the coil by burning may take place.

Coil Temperature Rise

When a current flows through the coil, the coil’s temperature rises to a measurable level, because of copper loss. If an alternating current flows, the temperature rises even more, due not only to the copper loss, but additionally to the iron loss of the magnetic materials, such as the core. Moreover, when a current is applied to the contact, heat is generated on the contacts, raising the coil temperature even higher (however, with relays whose switching current is rated at 2 A or lower, this rise is insignificant).

Temperature Rise by Pulsating Voltage

When a pulsating voltage having an ON time of less than 2 minutes is applied to the relay, the coil temperature rise varies, and is independent of the duration of the ON time, depending only on the ratio of the ON time to the OFF time. The coil temperature in this case does not rise as high as when a voltage is continuously applied to the relay.

Energization time	Release temperature rise
Continuous energization	100%
ON:OFF = 3:1 approx.	80%
ON:OFF = 1:1 approx.	50%
ON:OFF = 1:3 approx.	35%

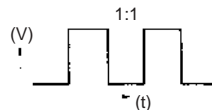

Changes in Must Operate Voltage by Coil Temperature Rise

The coil resistance of a DC-switching relay increases (as the coil temperature rises) when the coil has been continuously energized, de-energized once, and then immediately energized again. This increase in the coil resistance raises the voltage value at which the relay operates. Additionally, the coil resistance rises when the relay is used at a high ambient temperature.

Maximum Must Operate Voltage

The maximum voltage applicable to a relay is determined in accordance with the coil temperature rise and the coil insulation materials' heat resistivity, electrical as well as mechanical life, general characteristics, and other factors.

If a voltage exceeding the maximum voltage is applied to the relay, it may cause the insulation materials to degrade, the coil to be burnt, and the relay to not operate at normal levels. Actually, however, there are occasions when the maximum voltage is exceeded to compensate for fluctuation in the supply voltage. In this event, pay attention to the following points.

The coil temperature must not exceed the temperature that the spool and wound wire constituting the coil can withstand. The following table shows the wires often used for a coil. In this table, the coil temperature is measured through calculation of the coil resistance.

Wire material	Maximum coil temperature
Polyurethane (UEW)	120°C
Polyester (PEW)	130°C

How to Calculate Coil Temperature

$$t = \frac{R2 - R1}{R1} (234.5 + T1) + T1 \text{ [}^\circ\text{C]}$$

where,

- R1 (Ω): coil resistance before energization
- R2 (Ω): coil resistance after energization
- T1 (°C): coil temperature (ambient) before energization
- t (°C): coil temperature after energization

Before using the relay confirm that there are no problems.

DC Input Power Source

Pay attention to the coil polarity of the DC-switching relay. Power sources for DC-operated relays are usually a battery or a DC power supply, either with a maximum ripple of 5%. If power is supplied to the relay via a rectifier, the must operate and must release voltages vary with the ripple percentage. Therefore, check the voltages before actually using the relay. If the ripple component is extremely large, beat may occur. If this happens, it is recommended that a smoothing capacitor be inserted as shown in the following diagram.

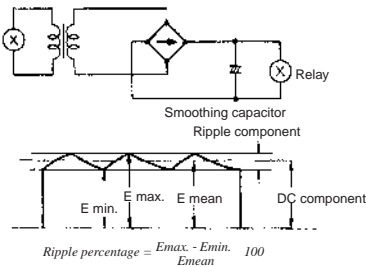

where,

- E max.: maximum value of ripple component
- E min.: minimum value of ripple component
- E mean: mean value of DC component

If the voltage applied to the DC-operated coil increases or decreases slowly, each contact of a multi-pole contact relay may not operate at the same time. It is also possible for this situation to result in the must operate voltage varying each time the relay operates. Either way, circuit sequencing will not be correct. In critical applications, the use of a Schmitt circuit is recommended to reshape the DC waveform to trigger all contacts of the relay at the same time.

Relay Driving Signal Waveform

A long rise time and/or fall time of the signal driving the relay may prolong the operate time and/or release time of the relay. This situation may shorten the life of the contacts. If this situation cannot be avoided, providing a Schmitt trigger circuit at the circuit stage preceding the relay circuit will shape a waveform with sharp transitions, as shown in the following diagram:

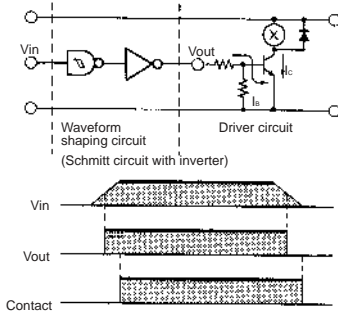

If the Schmitt trigger circuit is configured of transistors, a residual voltage may exist in the output of the circuit. Therefore, confirm that the rated voltage is present across the relay coil, or that the residual voltage drops to zero when the relay releases. When an IC (e.g., TC74HC132P) is used, this value is close to zero.

Cyclic Switching of AC Load

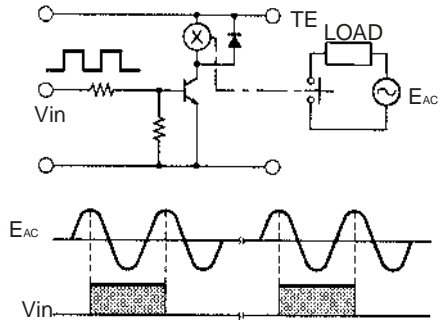

If the relay operates in synchronization with the supply voltage, the life of the relay may be shortened. When designing the control system in which the relay is used, estimate the life of the relay and thus the reliability of the overall system under actual operating conditions. Moreover, construct the circuit so that the relay operates in a random phase or in the vicinity of the zero point.

Dark Current in OFF Time

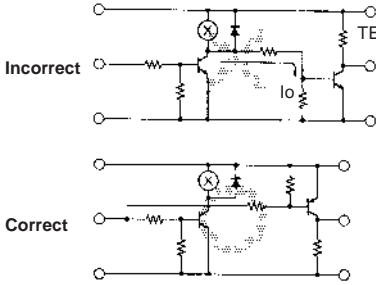

A circuit that produces a control output as soon as the relay operates must be carefully designed. In the example on the left, electrode dark current flows as shown when the relay operates. When dark current flows into the relay coil, the relay's resistivity to shock and vibration may degrade.

Overcoming Beat in DC Relays

When using AC power to generate power for operating a DC relay, the use of half-wave rectification causes the formation of a pulsating current. Therefore, when the capacitance of the smoothing capacitor C is low, the relay generates a beat. However, when a bridge rectification circuit is used, the frequency of the pulsating current doubles, generating no beat even when a smoothing capacitor C is not provided. The bridge rectification circuit can provide a higher rectification efficiency to increase the contact attraction, which is desirable in terms of prolonging the service life of the contact.

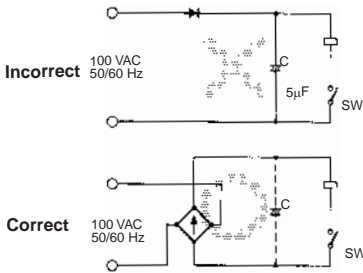

Voltage Considerations for AC Relays

For stable relay operation, a voltage +10% to -20% of the rated voltage should be applied to the relay. The voltage applied to the relay must be a sine wave. When a commercial power source is used, there should be no problem. However, if an AC stabilized power source is used, either beat or abnormal heating may occur, depending on the wave distortion of the power source. A shading coil is used to suppress beat in an AC current coil, but wave distortion defeats this function.

When a motor, solenoid, transformer, or other device is connected to the same power line source as the relay controller, and any of these devices causes a drop in the line voltage, the relay may vibrate, damaging the contact. This commonly occurs when a small transformer is added to the line, when the transformer is too small, when long wiring is used, or when thin wiring is used in the customer's premises. Be aware of this phenomenon, as well as normal voltage fluctuations. Should this problem occur, check the change in voltage with a synchroscope or the like, and take appropriate countermeasures. Effective countermeasures include replacing the relay with a special relay suited to the circumstances, or use of a DC circuit and inclusion of a capacitor to compensate for the voltage change, as shown in the following circuit diagram.

Voltage change compensation circuit incorporating a capacitor

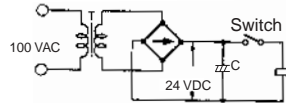

■ **Contacts**

The contacts are the most important constituent of a relay. Their characteristics are significantly affected by factors such as the material of the contacts, voltage and current values applied to them (especially, the voltage and current waveforms when energizing and de-energizing the contacts), the type of load, operating frequency, atmosphere, contact arrangement, and bounce. If any of these factors fail to satisfy predetermined values, problems such as metal deposition between contacts, contact welding, wear, or rapid increase in the contact resistance may occur.

Switching voltage (AC, DC)

When a relay breaks an inductive load, a fairly high counterelectromotive force (counter emf) is generated in the relay's contact circuit. The higher the counter emf, the greater the damage to the contacts. This may result in a significant decrease in the switching power of DC-switching relays. This is because, unlike the AC-switching relay, the DC-switching relay does not have a zero-cross point. Once arc has been generated, it does not easily diminish, prolonging the arc time. Moreover, the unidirectional flow of the current in a DC circuit may cause metal deposition to occur between contacts and the contacts to wear rapidly (this is discussed later).

Despite the information a catalog or data sheet sets forth as the approximate switching power of the relay, always confirm the actual switching power by performing a test with the actual load.

Switching Current

The quantity of electrical current which flows through the contact directly influences the contact' characteristics. For example, when the relay is used to control an inductive load such as a motor or a lamp, the contacts will wear more quickly, and metal deposition between the mating contacts will occur more often as the inrush current to the contacts increases. Consequently, at some point the contacts may not be able to open.

Contact Materials

Selection of an appropriate contact material according to the load to be opened or closed is important. Several contact materials and their properties are listed below.

Contact Materials and Feature

P. G. S. Alloy	This material has excellent corrosion resistance and is suitable for very small current circuits. (Au : Ag : Pt = 69 : 25 : 6)
AgPd	This material exhibits good corrosion and sulphur resistance. In a dry circuit, it attracts organic gas to generate a polymer, therefore it is usually plated with gold or other material.
Ag	This material has the highest electric and heat conductivities among all metals. It exhibits low contact resistance, but easily forms sulphide film in a sulphide gas environment. This may result in defective contact performance at a low-voltage small-current operation.
AgCdO	This material exhibits the same high electric conductivity as silver, low contact resistance, and excellent deposition resistance. It easily forms sulphide film in a sulphide gas environment.
AgNi	This material exhibits the same high electric conductivity as silver and excellent arc resistance.
AgSnIn	This material exhibits excellent deposition resistance and exhaustion resistance.
AgW	This material exhibits a high hardness and melting point. It also exhibits excellent arc resistance and superior resistance to deposition and transfer. However, it shows high contact resistance and inferior environmental resistance.

Contact Protection Circuit

A contact protection circuit, designed to prolong the life of the relay, is recommended. This protection will have the additional advantages of suppressing noise, as well as preventing the generation of carbide and nitric acid, which otherwise would be generated at the contact surface when the relay contact is opened. However, unless designed correctly, the protection circuit may produce adverse effects, such as prolonging the release time of the relay.

The following table lists examples of contact protection circuits.

Circuit example	Applicability		Features and remarks	Element selection
	AC	DC		
<p>CR</p>	Fair	Good	Load impedance must be much smaller than the RC circuit when the relay operates on an AC voltage.	Optimum C and R values are: C: 1 to 0.5 μF for 1–A switching current R: 0.5 to 1 Ω for 1–V switching voltage
	Good	Good	The release time of the contacts will be delayed when a relay solenoid is used as a load. This circuit is effective if connected across the load when the supply voltage is 24 to 48 V. When the supply voltage is 100 to 240 V, connect the circuit across the contacts.	These values do not always agree with the optimum values due to the nature of the load and the dispersion in the relay characteristics. Confirm optimum values experimentally. Capacitor C suppresses discharge when the contacts are opened, while resistor R limits the current applied when the contacts are closed the next time. Generally, employ a capacitor C whose dielectric strength is 200 to 300 V. If the circuit is powered by an AC power source, employ an AC capacitor (non-polarized).
<p>Diode</p>	Poor	Good	The energy stored in a coil (inductive load) reaches the coil as current via the diode connected in parallel with the coil, and is dissipated as Joule (measurable) heat by the resistance of the inductive load. This type of circuit delays the release time more than the RC type.	Employ a diode having a reverse breakdown voltage of more than 10 times the circuit voltage and a forward current rating greater than the load current. A diode having a reverse breakdown voltage two to three times that of the supply voltage can be used in an electronic circuit where the circuit voltage is not particularly high.
<p>Diode + Zener Diode</p>	Poor	Good	This circuit effectively shortens release time in applications where the release time of a diode protection circuit proves to be too slow.	The zener diode breakdown voltage should be about the same as the supply voltage.
<p>Varistor</p>	Good	Good	By utilizing the constant-voltage characteristic of a varistor, this circuit prevents high voltages from being applied across the contacts. This circuit also somewhat delays the release time. This circuit, if connected across the load, is effective when the supply voltage is 24 to 48 V. If the supply voltage is 100 to 240 V, connect the circuit across the contacts.	–

Avoid use of a surge suppressor in the manner shown below.

<p>This circuit arrangement is very effective for diminishing sparking (arcing) at the contacts, when breaking the circuit. However, since electrical energy is stored in C (capacitor) when the contacts are open, the current from C flows into the contacts when they close. Therefore, metal deposition is likely to occur between mating contacts.</p>	<p>This circuit arrangement is very useful for diminishing sparking (arcing) at the contacts when breaking the circuit. However, since the charging current to C flows into the contacts when they are closed, metal deposition is likely to occur between the mating contacts.</p>

Although it is considered that switching a DC inductive load is more difficult than a resistive load, an appropriate contact protection circuit can achieve almost the same characteristics.

■ Latching Relays

Avoid use in locations subject to excessive magnetic particles or dust.

Avoid use in magnetic fields (over 8,000 A.m).

Take measures to preventing problems caused by vibration or shock. Problems may originate from other relay(s) operating or releasing on the same panel.

Avoid simultaneous energization of the set and reset coils, even though both coils can be continuously energized.

Avoid use under conditions where excessive surge-generating sources exist in the coil power source.

When planning to mount multiple relays together, observe the minimum mounting interval of each type of relay.

Drive Circuit (Double-winding Relays G5AK, G6AK, G6BK, etc.)

When a DC-switching latching relay is used in one of the circuits shown in the following diagram, the relay contacts may be released from the locked state unless a diode (enclosed in the dotted box in the circuit diagram) is connected to the circuit.

Circuits

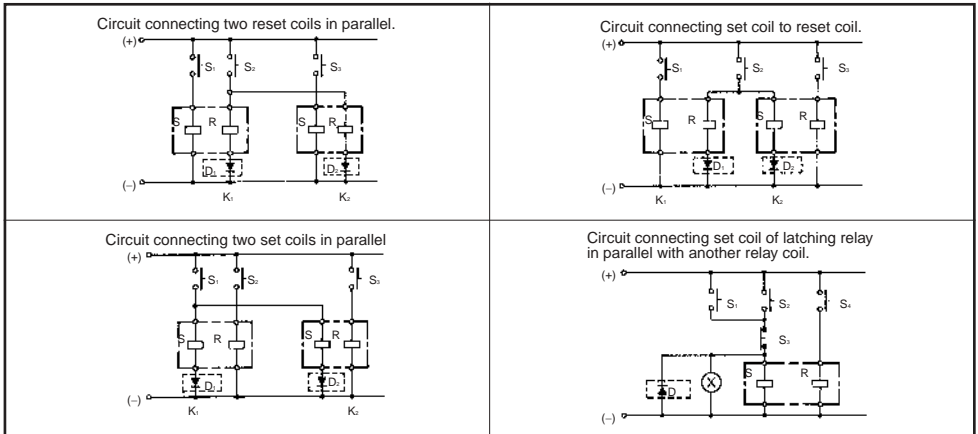

When connecting a diode to the relay circuit, be sure to use a diode with a repetitive peak-inverse voltage, and a DC reverse voltage sufficient to withstand external noise or surge. Also be sure that the diode has an average rectified current greater than the coil current.

If the contact of the relay is used to de-energize the relay, the relay may not operate normally. Avoid using the relay in a circuit like the one shown below:

Incorrect Use:

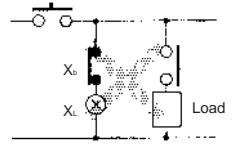

X_L : Latching relay
 X_C : NC contact of relay

■ PCB Design

Soldering

As demands for more compact electronic devices have grown, so have demands declined for the plug-in relays that requires a bulky socket for connection. This trend has lead to the development of relays that can be soldered directly onto the PCB. Smaller relays have made possible great density increases on the PCB, which in turn reduces the size of the product or device. However, unless the relay is fully sealed, when soldered onto a PCB, flux may penetrate into the housing, adversely affecting the internal circuitry.

The following points will help when designing a product which uses relays. This section points out details to be noted when soldering a relay to a PCB.

PCB Selection

In general, relays are directly mounted and soldered onto a PCB. Although seemingly an uninvolved process, soldering and its related processes of flux application, relay mounting, heat application, and washing can be detrimental to a relay's performance. For example, if the PCB were to warp, the internal mechanism of the relay could become distorted, degrading the performance characteristics. Thus it could be said that the relay's characteristics are also affected by the size, thickness, and material of the PCB. Therefore, carefully select a PCB that will not jeopardise the performance of the relay.

PCB MATERIALS

Generally, the substrate of a PCB is made of glass epoxy (GE), paper epoxy (PE), or paper phenol (PP). Of these, the glass-epoxy or paper-epoxy PCB is recommended for mounting relays. See the following table

Item	Epoxy Based		Phenol-based
	Glass Epoxy (GE)	Paper Epoxy (PE)	Paper Phenol (PP)
Electrical characteristics	High insulation resistance. Insulation resistance hardly affected by humidity.	Fair	Insulation resistance degraded by humidity.
Mechanical characteristics	Little expansions/shrinkage caused by change in temperature or humidity. Suitable for through-hole PCBs and multi-layered PCBs.	Fair	Much expansion/shrinkage caused by changes in temperature or humidity. Not suitable for through-hole PCB.
Cost Effectiveness	Expensive	Fair	Fair

PCB Thickness

PCBs having a thickness of 0.8, 1.2, 1.6, or 2.0 mm are generally used. A PCB that is 1.6 mm thick is best for mounting a PCB relay, considering the weight of the relay and the length of the terminals. (The terminal length of OMRON relays is 3, 3.5, or 4.0 to 5.0 mm.)

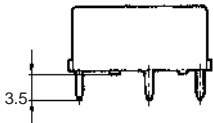

Terminal Hole Diameter and Land Diameter

Select the appropriate terminal hole and land diameters from the following table, based on the PCB mounting hole drawing. Land diameters may be reduced to less than those listed below if the through-hole connection process is to be employed.

Terminal Hole and Land Diameters

Terminal Hole Diameter		Minimum Land Diameter
Normal	Tolerance	
0.6 mm	±0.1 mm	1.5 mm
0.8 mm		1.8mm
1.0 mm		2.0mm
1.2 mm		2.5mm
1.3 mm		2.5mm
1.5 mm		3.0mm
1.6 mm		3.0mm
2.0 mm		3.0mm

Shape of Lands

The land section should be on the center line of the copper-foil pattern, so that the soldered fillets become uniform.

Correct	
Incorrect	

A break in the circular land area will prevent molten solder from filling holes reserved for components which must be soldered manually after the automatic soldering of the PCB is complete.

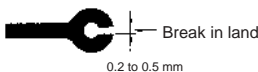

Conductor Width and Thickness

The following thickness of copper foil are standard: 35 μm and 70 μm. The conductor width is determined by the current flow and allowable temperature rise. Refer to the chart below.

Conductor Width and Carry Current
(according to IEC Pub326-3)

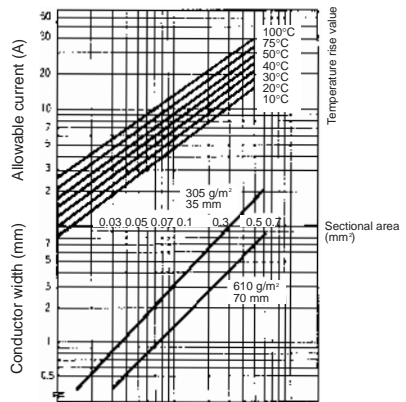

Conductor Pitch

The conductor pitch on a PCB is determined according to the insulation resistance between conductors and the environmental conditions under which the PCB is to be placed. The following graph shows the general relationship between the voltage between conductors and the conductor pitch on a PCB. However, if the PCB must conform to safety organization standards (such as UL, CSA, VDE, etc.), priority must be given to fulfilling their requirements.

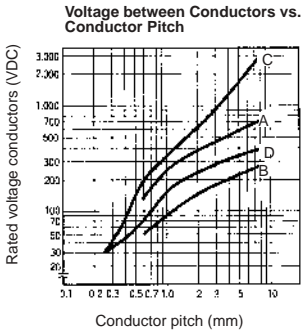

- A = w/o coating at altitude of 3,000 m max.
- B = w/o coating at altitude of 3,000 m or higher but lower than 15,000 m
- C = w/coating at altitude of 3,000 m max.
- D = w/coating at altitude of 3,000 m or higher

Temperature and Humidity

PCBs expand or contract with changes in temperature. Should expansion occur with a relay mounted on the PCB, the internal components of the relay may be shifted out of operational tolerance. As a result, the relay may not be able to operate with its normal characteristics.

PCB materials have “directionality,” which means that a PCB generally has expansion and contraction coefficients 1/10 to 1/2 higher in the vertical direction than in the horizontal direction. Conversely, its warp in the vertical direction is 1/10 to 1/2 less than in the horizontal direction. Therefore, take adequate counter-measures against humidity by coating the PCB. Should heat or humidity be entirely too high, the relay’s physical characteristics will likewise be affected. For example, as the heat rises the PCB’s insulation resistance degrades. Mechanically, PCB parts will continue to expand as heat is applied, eventually passing the elastic limit, which will permanently warp components.

Moreover, if the relay is used in an extremely humid environment, silver migration may take place.

Gas

Exposure to gases containing substances such as sulphuric acid, nitric acid, or ammonia can cause malfunctions such as faulty contacting in relays. They can also cause the copper film of a PCB to corrode, or prevent positive contacts between the PCB’s connectors. Of the gases mentioned, nitric acid is particularly damaging as it tends to accelerate the silver migration. As a counter-measure against gas exposure damage, the following processes on the relay and PCB have proved useful.

Item	Process
Outer Casing, housing	Sealed construction by using packing, etc
Relay	Use of simplified hermetically sealed type relay, DIP relay, reed relay
PCB, Copper Firm	Coating
Connector	Gold-plating, rhodium-plating process

Vibration and Shock

Although the PCB itself is not usually a source of vibration or shock, it may simplify or prolong the vibration by resonate with external vibrations or shocks. Securely fix the PCB, paying attention to the following points.

Mounting Method	Process
Rack Mounting	No gap between rack’s guide & PCB
Screw Mounting	Securely tighten screw. Place heavy components such as relays on part of PCB near where screws are to be used. Attach rubber washers to screws when mounting components that are affected by shock (such as audio devices.)

Mounting Position

Depending on where the relay is mounted, the function of the relay (and the performance of the circuit which includes the relay) may be adversely affected.

The relay may malfunction if it is mounted near a transformer or other device that generates a large magnetic field, or much heat. Provide an adequate distance between the relay and such devices.

Also, keep the relay away from semiconductor devices, if they are to be mounted on the same PCB.

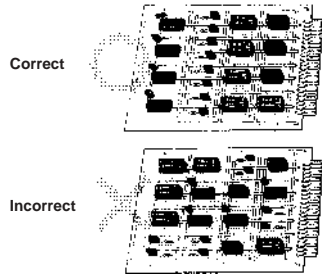

Mounting Direction

To allow a relay to operate to its full capability, adequate consideration must be given to the mounting direction of the relay. Relay characteristics that are considerably influenced by mounting direction are shock resistance, life, and contact reliability.

Shock Resistance

Ideally, the relay must be mounted so that any shock or vibration is applied to the relay at right angles to the operating direction of the armature of the relay. Especially when a relay’s coil is not energized, the shock resistance and noise immunity are significantly affected by the mounting direction of the relay.

Life

When switching a heavy load that generates arc (generally, having a greater impedance than that of the relay coil), substances spattered from the contact may accumulate in the vicinity, resulting in degradation of the insulation resistance of the circuit. Mounting the relay in the correct direction is also important in preventing this kind of degradation of the insulation resistance.

Contact Reliability

Switching both a heavy and a minute load with a single relay contact is not recommended. The reason for this is that the substances scattered from the contact when the heavy load is switched degrade the contact when switching the minute load. For example, when using a multi-pole contact relay, avoid the mounting direction or terminal connections in which the minute load switching contact is located below the heavy load switching contact.

Mounting Interval

When mounting multiple relays side by side on a PCB, pay attention to the following points:

When many relays are mounted together, they may generate an abnormally high heat due to the thermal interference between the relays. Therefore, provide an adequate distance between the relays to dissipate the heat. When using a relay, be sure to check the minimum mounting interval.

Also, if multiple PCBs with relays are mounted to a rack, the temperature may rise. In this case, preventive measures must be taken so that the ambient temperature falls within the rated value.

PATTERN LAYOUT

Countermeasures Against Noise

The relay can be a noise source when viewed from a semiconductor circuit. This must be taken into consideration when designing the layout positioning of the relay and other semiconductor components on the PCB.

Keep the relay away from semiconductor components as far away as possible.

Locate the surge suppressor for the relay coil as close to the relay as possible.

Do not route wiring for signals such as audio signals that are likely to be affected by noise below the relay.

Design the shortest possible pattern.

One method for separating the power source and relay from other electronic components is to use shielded patterns.

Coating

As is also the case in humid environments, coating the PCB is recommended to prevent the insulation of its pattern from being degraded by gases containing harmful substances. When coating the PCB, however, care must be exercised not to allow the coating agent to penetrate into the relays mounted on the PCB; otherwise, faulty contact of the relay may occur due to sticking or coating. Moreover, some coating agents may degrade or adversely affect the relay. Select the coating agent carefully.

Type of Coating

Item	Applicability to PCB with relays mounted	Feature
Epoxy	Good	Good insulation. Performing this coating is a little difficult, but has no effect on relay contact.
Urethane	Good	Good insulation and easy to coat. Be careful not to allow the coating on the relay itself, as thinner-based solvents are often used with this coating.
Silicon	Good	Good insulation and easy to coat. However, silicon gas may cause faulty contact of relay.

■ **Automatic Mounting of Relay on PCB**

THROUGH-HOLE MOUNTING

The following tables list the processes required for mounting a relay onto a PCB and the points to be noted in each process.

Process 1: Placement

Do not bend any terminal of the relay to use it as a self-clinching relay or the relay may malfunction.

It is recommended to use magazine-packaged self-clinching relays for placement onto the PCB.

Possibility of Automatic Placement

Construction	Unsealed	Flux protection	Fully sealed
Magazine-packaged relay Self-clinching relays	NO	YES	YES

Process 2: Flux Application

To apply flux to a flux protection or fully sealed relay, a sponge soaked with flux can be used. Place the relay in the holes drilled in the PCB and press the PCB (with the relay still mounted) firmly against the sponge. The flux will be pushed up the relay's contact legs, and through the PCB holes. This method must never be applied with an unsealed relay because the flux will penetrate into the relay.

The flux used with the sponge must be a non-corrosive resin-type flux.

For the flux solvent, use an alcohol-based solvent, which tends to be less chemically reactive.

Apply the flux sparingly and evenly to prevent penetration into the relay. When dipping the relay terminals into liquid flux, be sure to adjust the flux level, so that the upper surface of the PCB is not flooded with flux.

Possibility of Dipping Method

Unsealed	Flux protection	Fully sealed
NO	YES	NO

Process 3: Transportation

When the PCB is transported, the relay mounted on the PCB may be lifted from the board surface due to vibration. This can be prevented if the relay mounted on the PCB has self-clinching terminals.

Process 4: Preheating

Preheat the PCB at a temperature of 100°C maximum within a period of approximately one minute for smooth soldering. The characteristics of the relay may change if it is heated at a high temperature for a long time.

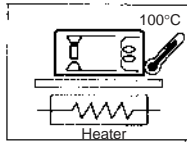

Possibility of Preheating

Unsealed	Flux protection	Fully sealed
NO	YES	NO

Process 5: Soldering

Flow soldering is recommended to assure a uniform solder joint.

- Solder: JIS Z3282, H60, or H63*
- Solder temperature and soldering time: 250°C, 5 s max.
- Adjust the level of the molten solder so that the PCB is not flooded with solder.

Possibility of Automatic Soldering

Unsealed	Flux protection	Fully sealed
NO	YES	YES

Manual Soldering

Complete the soldering operation quickly. Use the correct wattage of soldering iron. Do not overheat while smoothing the applied solder with the tip of the iron.

- Solder: JIS Z3282, H60, or H63 (containing resin-type flux)
- Soldering iron: rated at 30 to 60 W
- Tip temperature: 280°C to 300°C
- Soldering time: 3 s max.
- The following table contains recommended solders:

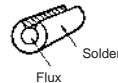

Type	Sparkle solder
Applicable solder diameter	0.8 to 1.6 mm
Sn	58.8%
Flux content	1.67%
Impurities	JIS Z3282 Class A
Spread rate	90%
Storage	3 months max.

Possibility of Manual Soldering

Unsealed	Flux protection	Fully sealed
YES	YES	YES

The solder in the illustration shown above is provided with a cut section to prevent the flux from splattering.

Process 6: Cooling

Upon completion of automatic soldering, use a fan or other device to forcibly cool the PCB. This helps prevent the relay and other components from deteriorating from the residual heat of soldering.

Fully sealed relays are washable. Do not, however, put fully sealed relays in a cold cleaning solvent immediately after soldering or the seals may be damaged.

Flux protection	Fully sealed
Necessary	Necessary

Process 7: Cleaning

Avoid cleaning the soldered terminals whenever possible. When a resin-type flux is used, no cleaning is necessary. If cleaning cannot be avoided, exercise care in selecting an appropriate cleaning solvent.

Cleansing Method

Unsealed	Flux protection	Fully sealed
Boiling cleaning and immersion cleaning are not possible. Clean only the back of the PCB with a brush.		Boiling cleaning and immersion cleaning are possible. Ultrasonic cleaning will have an adverse effect on the performance of relays not specifically manufactured for ultrasonic cleaning. When cleaning the G2R or any other relay, the ambient temperature must be within the permissible ambient operating temperature range of the relay.

List of Cleaning Solvents

Solvent		Fully Seated
Chlorine-based	Perochlene Chlorosolder Trichloroethylene	Yes
Water-based	Indusco Holys	Yes
Alcohol-based	IPA Ethanol	Yes
Others	Thinner Gasoline	No
Cleaning method		Automatic cleaning Ultrasonic cleaning (see note 4)

Note: 1. Consult your OMRON representative before using any other cleaning solvent. Do not use Freon-TMC-based, thinner-based, or gasoline-based cleaning solvents.

- Worldwide efforts are being made at discontinuing the use of CFC-113-based (fluorochlorocarbon-based) and trichloroethylene-based cleaning solvents. The user is requested to refrain from using these cleaning solvents
- It may be difficult to clean the space between the relay and PCB using hydrogen-based or alcohol-based cleaning solvent. It is recommended the stand-off-type be used G6A-□-ST when using hydrogen-based or alcohol-based cleaning solvents.
- Ultrasonic cleaning may have an adverse effect on the performance of relays not specifically manufactured for ultrasonic cleaning. Please refer to the model number to determine if your relay is intended to be cleaned ultrasonically.

Process 8: Coating

Do not apply a coating agent to any flux-resistant relay or relay with a case because the coating agent will penetrate into the relay and the contacts may be damaged.

Some coating agents may damage the case of the relay. Be sure to use a proper coating agent.

Do not fix the position of relay with resin or the characteristics of the relay will change.

Resin	Fully Sealed
Epoxy	YES
Urethane	YES
Silicone	NO
Fluorine	YES

Soldering Profile

PCB RELAY THT TYPE – PROFILE OF SOLDER TEMPERATURE FOR LEAD FREE

Process flow chart

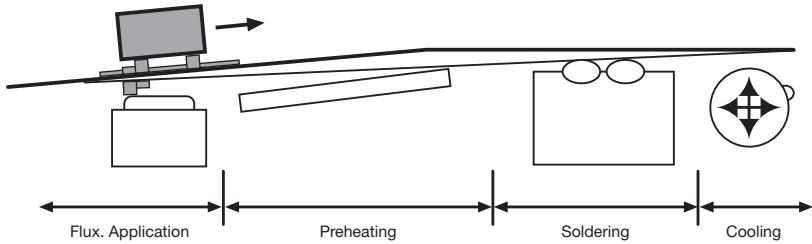

Solder Profile

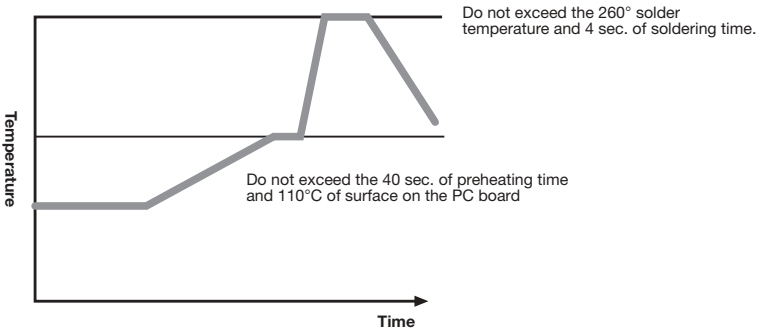

Soldering Heat Resistance – PCB (THT)

Item	Present (SnPB)	Lead Free Type
Preheating temperature	100°C	110°C
Preheating time	60 sec. max.	40 sec.
Solder temperature	Approx. 250°C	260°C
Soldering time	5 sec. max.	4 sec. max.

We recommend to confirm under the actual soldering condition at the customer before use.

SURFACE MOUNTING

The following tables list the processes required for mounting a relay onto a PCB and the points to be noted in each process.

Process 1: Cream Solder Printing

Do not use a cream solder that contains a flux with a large amount of chlorine or the terminals of the relay may be corroded.

Process 2: Relay Mounting

The holding force of the relay holder must be the same as or more than the minimum holding force value required by the relay.

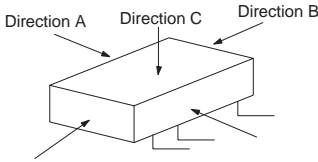

Direction	G6H	G6S
A	200 g max.	200 g max.
B	500 g max.	500 g max.
C	200 g max.	200 g max.

Process 3: Transportation

The relay may be dismounted by vibration during transportation. To prevent this, it is recommended an adhesive agent be applied to the relay's gluing part (protruding part) to tack the relay.

Adhesive Agent Application Methods

Dispenser Method	Screen-printing Method
NO	YES

SIGNAL RELAY SMD TYPE

Mounting temperature for Lead solder mounting

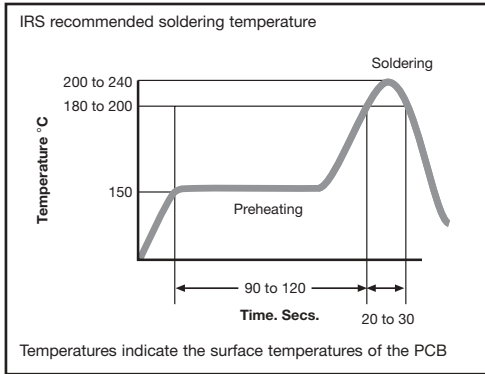

Mounting temperature for Lead-Free solder mounting

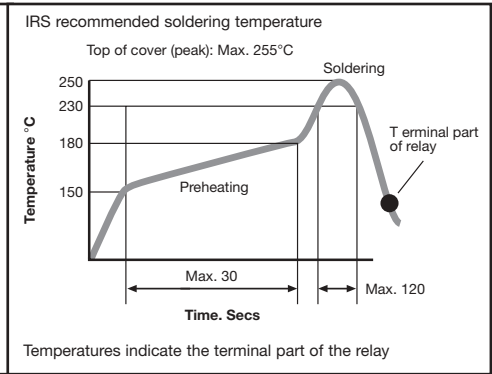

Cleaning



Boiling cleaning and immersion cleaning are recommended.



Ultrasonic cleaning will have an adverse effect on the performance of relays not specifically manufactured for ultrasonic cleaning.



List of Cleaning Solvent



Solvent		Fully Seated
Chlorine-based	Perochlene Chlorosolder Trichloroethylene	Yes
Water-based	Indusco Holys	Yes
Alcohol-based	IPA Ethanol	Yes
Others	Thinner Gasoline	No
Cleaning method		Automatic cleaning Ultrasonic cleaning (see note 4)



- Note:**
1. Consult your OMRON representative before using any other cleaning solvent. Do not use Freon-TMC-based, thinner-based, or gasoline-based cleaning solvents.
 2. Worldwide efforts are being made at discontinuing the use of CFC-113-based (fluorochlorocarbon-based) and trichloroethylene-based cleaning solvents. The user is requested to refrain from using these cleaning solvents
 3. It may be difficult to clean the space between the relay and PCB using hydrogen-based or alcohol-based cleaning solvent. It is recommended the stand-off-type be used G6A-□-ST when using hydrogen-based or alcohol-based cleaning solvents.
 4. Ultrasonic cleaning may have an adverse effect on the performance of relays not specifically manufactured for ultrasonic cleaning. Please refer to the model number to determine if your relay is intended to be cleaned ultrasonically.



Model		G5B	G5NB-E	G5SB
Features		Miniature relay	Compact single pole 5A high isolation relay CTI: 250 ROHS compliant	Environmentally friendly compact relay ROHS compliant
Appearance				
Dimensions (LxWxH)		22.4 x 11.9 x 14.4	20.5 x 7.2 x 15.3	20.3 x 10.3 x 15.8
Contact Ratings	Contact Form	SPST-NO	SPST-NO	SPST
	Contact Type	Single	Single	Single
	Contact Material	Ag	Ag Alloy	Ag
	Resistive Load	3 A at 125 VAC 3 A at 30 VDC	5 A at 250 VAC 5 A at 30 VDC	3 A at 125 VAC 5 A at 30 VDC
	Max. Switching Current	3 A	5 A	5 A
	Min. Permissible load	10 mA at 5 VDC	10 mA at 5 VDC	10 mA at 5 VDC
	Max. Switching Power	750 VA, 90 W	1,250 VA, 90 W	1250 VA, 150 W
	Max. Switching Voltage	250 VAC, 30 VDC	250 VAC, 30 VDC	250 VAC, 30 VDC
Coil ratings	Rated Voltage	5 to 24 VDC	5 to 24 VDC	5 to 24 VDC
	Power Consumption (Approx.)	360 mW (200 mW high sensitivity)	200 mW	400 mW (200 mW high sensitivity)
Endurance	Electrical (operations)	200,000 min	100,000 (5A / 250 VAC) 50,000 (5A / 30 VDC)	50,000 min
	Mechanical (operations)	5,000,000 min	5,000,000	5,000,000 min
Dielectric strength	Between coil and contacts	2,000 VAC	4,000 VAC	4,000 VAC
	Between contacts of different polarity	–	–	–
	Between contacts of same polarity	750 VAC	750 VAC	1,000 VAC
Ambient temperature (operating)		-40°C to 70°C	-40°C to 85°C	-40°C to 70°C
Variations	Single Side Stable	•	•	•
	Single Winding Latching			
	Double Winding Latching			
	PCB Terminal	•	•	•
	Plug-in Terminal			
	Quick Connect Terminal			
	Panel Mount			
	Fully sealed			
Flux Protection	•	•		
Approved Standards		UL, CSA, IEC (TÜV)	UL, CSA, EN	UL, CSA, EN
Page		41	48	53

Model		G6M	G6D
Features		Slim single in-line miniature relay	Slim miniature relay capable of relaying controller output
Appearance			
Dimensions (LxWxH)		20.3 x 5.1 x 17.7	17.5 x 6.5 x 12.5
Contact Ratings	Contact Form	SPST-NO	SPST-NO
	Contact Type	Single	Single
	Contact Material	AgNi	AgCdO (Cd free planned 1 Apr 05)
	Resistive Load	3 A at 250 VAC 3 A at 30 VDC	5 A at 250 VAC 5 A at 30 VDC
	Max. Switching Current	5 A	5 A
	Min. Permissible load	10 mA at 5 VDC	10 mA at 5 VDC
	Max. Switching Power	750 VA, 90 W	1,250 VA, 150 W
	Max. Switching Voltage	270 VAC, 125 VDC	250 VAC, 30 VDC
Coil ratings	Rated Voltage	5 to 24 VDC	5 to 24 VDC
	Power Consumption (Approx.)	120 mW	200 mW
Endurance	Electrical (operations)	100,000 min	100,000 min
	Mechanical (operations)	20,000,000 min	20,000,000 min
Dielectric strength	Between coil and contacts	3,000 VAC	3,000 VAC
	Between contacts of different polarity	–	–
	Between contacts of same polarity	750 VAC	750 VAC
Ambient temperature (operating)		-40°C to 85°C	-40°C to 70°C
Variations	Single Side Stable	•	•
	Single Winding Latching		
	Double Winding Latching		
	PCB Terminal	•	•
	Plug-in Terminal		
	Quick Connect Terminal		
	Panel Mount		
	Fully sealed	•	•
Flux Protection			
Approved Standards		UL, CSA, EN	UL, CSA, IEC, EN
Page		56	60

Model		G6B		G2RG
Features		Sub-miniature relay		Power Relay with 2 x 1.5 mm contact gap. Meets requirements of european UPS standards. ROHS compliant.
Appearance				
Dimensions (LxWxH)		20 x 10 x 10	20 x 11 x 11	29 x 13.5 x 25.5
Contact Ratings	Contact Form	SPST-NO	SPST-NO/NC, DPST-NO DPST-NC	DPST-NO
	Contact Type	Single		Single
	Contact Material	AgCdO (Cd free planned 1 Apr 05)		Ag Alloy
	Resistive Load	5 A at 250 VAC 5 A at 30 VDC		8 A at 250 VAC
	Max. Switching Current	5 A		8 A
	Min. Permissible load	10 mA at 5 VDC		10 mA at 5 VDC
	Max. Switching Power	1,250 VA, 125 W		2,000 VA, 240 W
Coil ratings	Rated Voltage	5 to 24 VDC		12 & 24 VDC
	Power Consumption (Approx.)	120 mW	300 mW	800 mW
Endurance	Electrical (operations)	100,000 min		10,000 min
	Mechanical (operations)	50,000,000 min		1,000,000 min
Dielectric strength	Between coil and contacts	3,000 VAC		5,000 VAC
	Between contacts of different polarity	–	2,000 VAC	3,000 VAC
	Between contacts of same polarity	1,000 VAC		1,000 VAC
Ambient temperature (operating)		-25°C to 70°C		-40°C to 70°C
Variations	Single Side Stable		•	•
	Single Winding Latching		•	
	Double Winding Latching		•	
	PCB Terminal		•	•
	Plug-in Terminal			
	Quick Connect Terminal			
	Panel Mount		•	
	Fully sealed			•
Flux Protection			•	
Approved Standards		UL, CSA, SEV, IEC, (TÜV), EN		UL, CSA, EN
Page		64		71



Model		G5Q-EU		G6RN	
Features		Compact low cost high isolation relay CTI: 250 ROHS compliant		Slim, low profile heavy duty relay ROHS compliant	
Appearance					
Dimensions (LxWxH)		20.3 x 10.3 x 15.8		28.5 x 10 x 15	
Contact Ratings	Contact Form	SPST-NO	SPDT	SPST-NO	SPDT
	Contact Type	Single		Single	
	Contact Material	Ag Alloy		AgNi (Au clad)	
	Resistive Load	10 A at 250 VAC 5 A at 30 VDC (NO)		8 A at 250 VAC 5 A at 30 VDC	
	Max. Switching Current	10 A (NO), 3 A (NC)		8 A	
	Min. Permissible load	10 mA at 5 VDC		10 mA at 5 VDC	
	Max. Switching Power	2,500 VA, 150 W		2,000 VA, 150 W	
	Max. Switching Voltage	277 VAC, 30 VDC		250 VAC, 30 VDC	
Coil ratings	Rated Voltage	5 to 24 VDC		5 to 48 VDC	
	Power Consumption (Approx.)	200 mW	400 mW	220-250 mW	
Endurance	Electrical (operations)	25,000 min (10 A / 250 VAC – NO) 100,000 min (3 A / 250 VAC – NC)		100,000 min	
	Mechanical (operations)	10,000,000 min		10,000,000 min	
Dielectric strength	Between coil and contacts	4,000 VAC		4,000 VAC	
	Between contacts of different polarity	–		–	
	Between contacts of same polarity	1,000 VAC		1,000 VAC	
Ambient temperature (operating)		-40°C to 85°C		-40°C to 85°C	
Variations	Single Side Stable	•		•	
	Single Winding Latching				
	Double Winding Latching				
	PCB Terminal	•		•	
	Plug-in Terminal				
	Quick Connect Terminal				
	Panel Mount				
	Fully sealed	•		•	
Flux Protection	•				
Approved Standards		UL, CSA, EN		UL, CSA, SEV, IEC, EN	
Page		75		79	



Model		G5LE		G5LB		G5LC-EU	
Features		Sub-miniature 'sugar cube' relay. ROHS compliant.		Low profile 10A sugar cube relay. ROHS compliant.		Sub-miniature 'sugar cube' single pole relay CTI: 250. ROHS compliant.	
Appearance							
Dimensions (LxWxH)		22.5 x 16.5 x 19		19.6 x 15.6 x 15.2		22.5 x 16.5x 19	
Contact Ratings	Contact Form	SPST-NO	SPST	SPDT, SPST-NO		SPST-NO	SPDT
	Contact Type	Single		Single		Single	
	Contact Material	AgSnO ² , AgSnin		AgSnO ²		Ag Alloy	
	Resistive Load	10 A at 120 VAC 8 A at 30 VDC		10 A at 250 VAC 8 A at 30 VDC		10 A at 240 VAC 10 A at 24 VDC (NO)	
	Max. Switching Current	10 A		10 A		10 A	
	Min. Permissible load	100 mA at 5 VDC		100 mA at 5VDC		100 mA at 5VDC	
	Max. Switching Power	1,200 VA, 150 W		2,500 VA, 240W		2,400 VA, 240W	
	Max. Switching Voltage	250 VAC, 30 VDC		250 VAC, 30 VDC		250 VAC, 30 VDC	
Coil ratings	Rated Voltage	5 to 48 VDC		3 to 48 VDC		5 to 24 VDC	
	Power Consumption (Approx.)	400 mW		360 mW		360 mW	
Endurance	Electrical (operations)	100,000 min		100,000 min		100,000	
	Mechanical (operations)	10,000,000 min		10,000,000 min		10,000,000	
Dielectric strength	Between coil and contacts	2,000 VAC		2,000 VAC		2,000 VAC	
	Between contacts of different polarity	-		-		-	
	Between contacts of same polarity	750 VAC		750 VAC		750 VAC	
Ambient temperature (operating)		-40°C to 85°C		-40°C to 85°C		-25°C to 85°C	
Variations	Single Side Stable	•		•		•	
	Single Winding Latching						
	Double Winding Latching						
	PCB Terminal	•		•		•	
	Plug-in Terminal						
	Quick Connect Terminal						
	Panel Mount						
	Fully sealed	•		•		•	
Flux Protection	•		•		•		
Approved Standards		UL, CSA, SEV, IEC, EN		UL, CSA, EN		UL, CSA, EN	
Page		83		88		92	

Model		G5CA		G6C	
Features		Flat power relay. ROHS compliant.		General purpose power relays	
Appearance					
Dimensions (LxWxH)		22 x 16 x 11		20 x 15 x 10	
Contact Ratings	Contact Form	SPST-NO		SPST-NO	SPST-NO/NC
	Contact Type	Single		Single	
	Contact Material	AgSnO ²		AgCdO (Cd free planned 1 Apr 05)	
	Resistive Load	10 A at 250 VAC 10 A at 30 VDC	10 A at 110 VAC	10 A at 250 VAC 10 A at 30 VDC	8 A at 250 VAC 8 A at 30 VAC
	Max. Switching Current	10 A	15 A	10 A	10 A
	Min. Permissible load	10 mA at 5 VDC		10 mA at 5 VDC	
	Max. Switching Power	2,500 VA, 300 W		2,500 VA, 300 W	2,000 VA, 240 W
	Max. Switching Voltage	250 VAC, 30 VDC		380 VAC, 125 VDC	
Coil ratings	Rated Voltage	5 to 48 VDC		3 to 24 VDC	
	Power Consumption (Approx.)	200 mW (150 mW high sensitivity version)		200 mW	
Endurance	Electrical (operations)	300,000 min	100,000 min	100,000 min	
	Mechanical (operations)	20,000,000 min		50,000,000 min	
Dielectric strength	Between coil and contacts	2,500 VAC		2,000 VAC	
	Between contacts of different polarity	–		–	2,000 VAC
	Between contacts of same polarity	1,000 VAC		1,000 VAC	
Ambient temperature (operating)		-25°C to 70°C		-25°C to 70°C	
Variations	Single Side Stable	•		•	
	Single Winding Latching			•	
	Double Winding Latching			•	
	PCB Terminal	•		•	
	Plug-in Terminal				
	Quick Connect Terminal	•			
	Panel Mount				
	Fully sealed	•		•	
Flux Protection	•		•		
Approved Standards		UL, CSA, SEV, SEMKO, IEC (TÜV)		UL, CSA, SEV, IEC (TÜV)	
Page		96		100	

Model		G2R		
Features		General purpose power relays		
Appearance				
Dimensions (LxWxH)		29 x 13 x 25.5		
Contact Ratings	Contact Form	SPST-NO, SPDT	SPST-NO, SPDT	DPST-NO, DPDT
	Contact Type	Single		
	Contact Material	AgCdO (Cd free planned 1 Apr 05)		
	Resistive Load	10 A at 250 VAC 10 A at 30 VDC	16 A at 250 VAC 16 A at 30 VDC	5 A at 250 VAC 5 A at 30 VDC
	Max. Switching Current	10 A	16 A	5 A
	Min. Permissible load	100 mA at 5 VDC	100 mA at 5 VDC	10 mA at 5 VDC
	Max. Switching Power	2,500 VA, 300 W	4,000 VA, 400 W	1,250 VA, 150 W
	Max. Switching Voltage	380 VAC, 125 VDC		
Coil ratings	Rated Voltage	5 to 100 VDC, 12 to 240 VAC		
	Power Consumption (Approx.)	DC: 530mW; 360mW high sensitivity version AC: 900mva		
Endurance	Electrical (operations)	100,000 min		
	Mechanical (operations)	DC: 20,000,000 min AC: 10,000,000 min		
Dielectric strength	Between coil and contacts	5,000 VAC		
	Between contacts of different polarity	–	–	3,000 VAC
	Between contacts of same polarity	1,000 VAC		
Ambient temperature (operating)		-40°C to 70°C		
Variations	Single Side Stable	•		
	Single Winding Latching	•		
	Double Winding Latching	•		
	PCB Terminal	•		
	Plug-in Terminal	•		
	Quick Connect Terminal	•		
	Panel Mount	•		
	Fully sealed	•		
Flux Protection	•			
Approved Standards		UL, CSA, SEV, SEMKO, IEC (TÜV), EN		
Page		109		

Model		G2RL		
Features		Low profile relays with Class F insulation available. ROHS compliant.		
Appearance				
Dimensions (LxWxH)		29 x 12.7 x 15.7		
Contact Ratings	Contact Form	SPST-NO, SPDT	SPST-NO, SPDT	DPST-NO, DPDT
	Contact Type	Single		
	Contact Material	AgSnO ₂	AgSnO ₂	AgNi
	Resistive Load	12 A at 250 VAC 12 A at 24 VDC	16 A at 250 VAC 16 A at 24 VDC	8 A at 250 VAC 8 A at 24 VDC
	Max. Switching Current	12 A	16 A	8 A
	Min. Permissible load	10 mA at 5 VDC		
	Max. Switching Power	3,000 VA, 280 W	4,000 VA, 380 W	2,000 VA, 240 W
	Max. Switching Voltage	440 VAC, 300 VDC		
Coil ratings	Rated Voltage	5 to 48 VDC		
	Power Consumption (Approx.)	400 mW		
Endurance	Electrical (operations)	50,000 min		
	Mechanical (operations)	20,000,000 min		
Dielectric strength	Between coil and contacts	5,000 VAC		
	Between contacts of different polarity	–	–	2,500 VAC
	Between contacts of same polarity	1,000 VAC		
Ambient temperature (operating)		-40°C to 85°C		
Variations	Single Side Stable	•		
	Single Winding Latching			
	Double Winding Latching			
	PCB Terminal	•		
	Plug-in Terminal			
	Quick Connect Terminal			
	Panel Mount			
	Fully sealed	•		
Flux Protection	•			
Approved Standards		UL, CSA, EN		
Page		130		

Model		G5RL-AC	G4W	
Features		Single-pole 16A power relay AC coil type	Relay with 10kV impulse and 4kV withstand voltages for power supply switching applications	
Appearance				
Dimensions (LxWxH)		29.0 x 12.7 x 15.7	30.5 x 19.5 x 30.5	
Contact Ratings	Contact Form	SPDT	SPST-NO	DPST-NO
	Contact Type	Single	Single	
	Contact Material	Ag Alloy (AgSnIn)	AgCdO (Cd free planned 1 Apr 05)	
	Resistive Load	AC 250V 16A (NO), DC 24V 16A (NO), AC 250V 5A (NC), DC 24V 5A (NC)	15 A at 250 VAC 15 A at 24 VDC	10 A at 250 VAC 10 A at 24 VDC
	Max. Switching Current	16 A (NO), 15 A (NC)	15 A	10 A
	Min. Permissible load	40 mA at 24 VDC	100 mA at 5 VDC	
	Max. Switching Power	AC 250V, DC24V	3,750 VA, 375 W	2,500 VA, 240 W
	Max. Switching Voltage	250 VAC, 24 VDC	250 VAC, 125 VDC	
Coil ratings	Rated Voltage	24 VAC to 240 VAC	12 to 100 VDC	
	Power Consumption (Approx.)	75 VA	800 mW	
Endurance	Electrical (operations)	50,000 min	100,000 min	
	Mechanical (operations)	10,000,000 min	5,000,000 min	
Dielectric strength	Between coil and contacts	6,000 VAC	4,000 VAC	
	Between contacts of different polarity	–	–	2,000 VAC
	Between contacts of same polarity	1,000 VAC	1,500 VAC	
Ambient temperature (operating)		-40°C to 70°C	-25°C to 55°C	
Variations	Single Side Stable			•
	Single Winding Latching			
	Double Winding Latching			
	PCB Terminal	•		•
	Plug-in Terminal			
	Quick Connect Terminal			•
	Panel Mount			
	Fully sealed			
Flux Protection	•			
Approved Standards		UL, VDE	UL, CSA, EN (VDE), SEV, SEMKO, DEMKO	
Page		135	139	

Model		G8P		G4A	
Features		Small, low cost power relays		Relay with 10kV impulse and 4kV withstand voltages for power supply switching applications	
Appearance					
Dimensions (LxWxH)		32.1 x 28.2 x 20.1		30.5 x 16 x 23.5	30.5 x 16 x 26.8
Contact Ratings	Contact Form	SPDT	SPDT	SPST-NO	
	Contact Type	Single			Single
	Contact Material	AgCdO ((Cd free planned 1 Apr 05)			AgSnO ₂
	Resistive Load	30 A at 250 VAC 20 A at 28 VDC	20/10 A at 250 VAC 20/10 A at 30 VAC	20 A at 250 VAC	
	Max. Switching Current	30 A	20/10 A	20 A	
	Min. Permissible load	500 mA at 5 VDC			100 mA at 5 VDC
	Max. Switching Power	7,500 VA, 560 W	5,000/2,000 VA, 560/2,380 W	5,000 VA	
	Max. Switching Voltage	250 VAC, 28 VDC			250 VAC
Coil ratings	Rated Voltage	5 to 110 VDC		5 to 24 VDC	
	Power Consumption (Approx.)	900 mW		900 mW	
Endurance	Electrical (operations)	100,000 min		100,000 min	
	Mechanical (operations)	10,000,000 min		2,000,000 min	
Dielectric strength	Between coil and contacts	2,500 VAC		4,500 VAC	
	Between contacts of different polarity	-		-	
	Between contacts of same polarity	1,500 VAC		1,000 VAC	
Ambient temperature (operating)		-55°C to 105°C		-20°C to 60°C	
Variations	Single Side Stable	•		•	
	Single Winding Latching				
	Double Winding Latching				
	PCB Terminal	•		•	
	Plug-in Terminal			•	
	Quick Connect Terminal	•			
	Panel Mount	•			
	Fully sealed	•			
Flux Protection			•		
Approved Standards		UL, CSA		UL, CSA, IEC, EN	
Page		144		150	

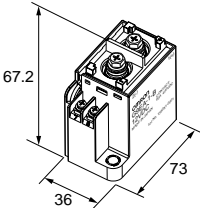
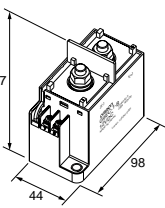
Model		G9EA		G9EC
		G9EA-1(-B)	G9EA-1(-B)-CA	G9EC-1(-B)
Classification		Switching/current conduction	High-current conduction	Switching/current conduction
Appearance				
Features		Standard model Compact, carries/switches 400 V, 60 A loads	Carries 100 A Low contact resistance when carrying current	Largest capacity in series Carries/switches 400 V, 200 A loads
Contact	Contact Form	SPST-NO		SPST-NO
	Contact structure	Double-break, single		Double-break, single
	Contact resistance	30 mΩ max. (0.6 mΩ typical)	10 mΩ max. (0.3 mΩ typical)	30 mΩ max. (0.2 mΩ typical)
	Switching voltage drop	0.1 V max. (for a carry current of 60 A)	0.1 V max. (for a carry current of 100 A)	0.1 V max. (for a carry current of 200 A)
	Electrical endurance	120 VDC, 100 A, 3,000 operations min.	400 VDC, 30 A, 1,000 operations min.	400 VDC, 200 A, 3,000 operations min.
		400 VDC, 60 A, 3,000 operations min.	120 VDC, 30 A, 2,500 operations min.	–
		400 VDC, 30 A, 30,000 operations min.	–	–
	Maximum switching current	100 A	30 A	200 A
	Rated carry current	60 A	100 A	200 A
	Short-time carry current	100 A (10 min)	150 A (10 min)	300 A (15 min)
	Maximum interruption current	600 A at 300 VDC (5 times)	–	1,000 A at 400 VDC (10 times)
Overload interruption	180 A at 400 VDC (100 times min.)	100 A at 120 VDC (150 times min.)	700 A at 400 VDC (40 times min.)	
Reverse polarity interruption	-60 A at 200 VDC (1,000 times min.)	–	-200 A at 200 VDC (1,000 times min.)	
Coil	Rated voltage	12, 24, 48, 60 & 100 VDC		12, 24, 48, 60 & 100 VDC
	Power consumption	Approx. 5 to 5.4 W		Approx. 11 W
Mechanical endurance		200,000 operations min.		200,000 operations min.

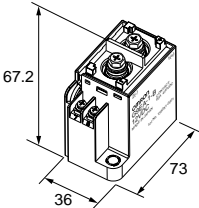
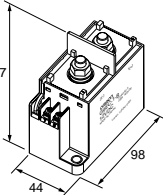
Model		G9EA		G9EC
		G9EA-1(-B)	G9EA-1(-B)-CA	G9EC-1(-B)
Classification		Switching/current conduction	High-current conduction	Switching/current conduction
Appearance				
Features		Standard model Compact, carries/switches 400 V, 60 A loads	Carries 100 A Low contact resistance when carrying current	Largest capacity in series Carries/switches 400 V, 200 A loads
Insulation resistance (see note 1)	Between Coil and Contacts	1,000 MΩ min		1,000 MΩ min
	Between contacts of the same polarity	1,000 MΩ min		1,000 MΩ min
Dielectric strength	Between Coil and Contacts	2,500 VAC, 1 min		2,500 VAC, 1 min
	Between contacts of the same polarity	2,500 VAC, 1 min		2,500 VAC, 1 min
Impulse withstand voltage (see note 2)		4,500 V		4,500 V
Ambient operating temperature		-40 to 70°C (with no icing or condensation)		-40 to 50°C (with no icing or condensation)
Ambient operating humidity		5% to 85%		5% to 85%
Terminals	Screw terminals	Yes		Yes
	Lead wire output	Yes		Yes
Page		154		161

Note: 1. The insulation resistance was measured with a 500 VDC megohmmeter.

2. The impulse withstand voltage was measured with a JEC-212 (1981) standard impulse voltage waveform (1.2 x 50 μs).

Single-pole 3-A Miniature Relay

- Impulse withstand voltage of 10 kV (between coil and contacts).
- Models available with 200-mW current consumption (High-sensitivity Type).
- High-capacity (8 A) type available.
- UL/CSA/TÜV approved.
- Standard and high capacity types Cd free.



Ordering Information

Classification	Contact form	Enclosure ratings	Model
Standard	SPST-NO	Flux protection	G5B-1
High-sensitivity			G5B-1-H
High-capacity			G5B-1-E

- Note:**
1. 6 VDC can be also produced.
 2. When ordering, add the rated coil voltage to the model number.
 Example: G5B-1 12 VDC
 Rated coil voltage

G5B - - VDC
 1 2 3

1. **Number of Poles**
1: 1 pole (SPST-NO)
2. **Classification**
H: High-sensitivity
E: High-capacity
3. **Rated Coil Voltage**
5, 12, 24 VDC

Specifications

■ Coil Ratings

Item	Standard type, high-capacity type			High-sensitivity type		
	5 VDC	12 VDC	24 VDC	5 VDC	12 VDC	24 VDC
Rated voltage	5 VDC	12 VDC	24 VDC	5 VDC	12 VDC	24 VDC
Rated current	72.0 mA	30.0 mA	15.0 mA	40.0 mA	16.7 mA	8.3 mA
Coil resistance	69.4 Ω	400 Ω	1,600 Ω	125 Ω	720 Ω	2,880 Ω
Must operate voltage	Standard type: 70% max. of rated voltage High-capacity type: 75% max. of rated voltage			75% max. of rated voltage		
Must release voltage	5% min. of rated voltage					
Max. voltage	140% (at 23°C)/110% (at 70°C) of rated voltage			160% (at 23°C)/130% (at 70°C) of rated voltage		
Power consumption	Approx. 360 mW			Approx. 200 mW		

■ Contact Ratings

Item	Standard type, high-capacity type		High-sensitivity type	
Load	Resistive load (cosφ = 1)		–	
Rated load	3 A at 125 VAC, 3 A at 30 VDC		8 A at 125 VAC, 8 A at 30 VDC	
Contact material	Ag		AgCdO (Cd free planned 1 Apr 05)	
Rated carry current	3 A		8 A	
Max. switching voltage	250 VAC, 30 VDC			
Max. switching current	3 A		8 A	
Max. switching power	750 VA, 90 W		2,000 VA, 240 W	
Failure rate (ref. value)	5 VDC, 10 mA		5 VDC, 100 mA	

Note: P level: $\lambda_{G0} = 0.1 \times 10^{-6}$ /operation (with an operating frequency of 120 operations/min).

■ Characteristics

Contact resistance	100 mΩ max.
Operate time	10 ms max.
Release time	10 ms max.
Insulation resistance	1,000 MΩ max. (at 500 VDC)
Dielectric strength	2,000 VAC, 50/60 Hz for 1 min between coil and contacts; 750 VAC, 50/60 Hz for 1 min between contacts of same polarity
Vibration resistance	Destruction: 10 to 55 to 10 Hz, 0.75-mm single amplitude (1.5-mm double amplitude) Malfunction: 10 to 55 to 10 Hz, 0.75-mm single amplitude (1.5-mm double amplitude)
Shock resistance	Destruction: 1,000 m/s ² Malfunction: 100 m/s ²
Endurance	Mechanical: 5,000,000 operations min. (at 18,000 operations/hr) Electrical: 200,000 operations min. (at 1,800 operations/hr) for standard type, high-sensitivity type 100,000 operations min. (at 1,200 operations/hr) for high-capacity type
Ambient temperature	Operating: -40°C to 70°C (with no icing)
Ambient humidity	Operating: 5% to 85%
Weight	Approx. 7 g

Note: The data shown above are initial values.

■ Approved Standards

UL508 (File No. E41643)/CSA C22.2 No.0, No.14 (File No. LR31928)

Model	Coil ratings	Contact ratings
G5B-1, G5B-1-H	3 to 24 VDC	3 A, 250 VAC (general use) 3 A, 30 VDC (resistive) 1/8 hp, 125 VAC/1/8 hp, 250 VAC TV-2 125 VAC

TÜV VDE0435 IEC255 (File No. R9251225)

Model	Coil ratings	Contact ratings	Condition
G5B-1, G5B-1-H	3 to 24 VDC	3 A, 250 VAC- (cosφ = 1) 3 A, 30 VDC= (0 ms)	Duty level: class III Operative range: 2 Pick-up class: class a Pollution degree: 2 Overvoltage category: II Material group: IIIa Ambient temperature: -40°C to 70°C
G5B-1-E		8 A, 125 VAC- (cosφ = 1) 8 A, 30 VDC= (0 ms)	

Engineering Data

Maximum Switching Power

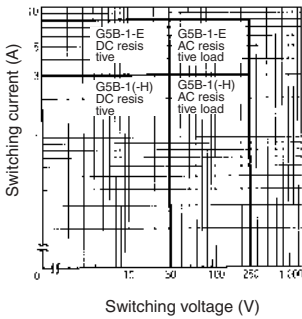

Endurance

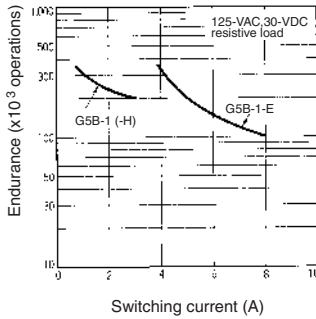

Ambient Temperature vs. Maximum Coil Voltage

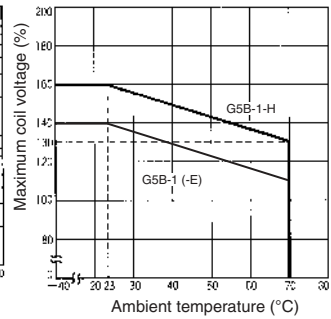

Note: The maximum coil voltage refers to the maximum value in a varying range of operating power voltage, not a continuous voltage.

Dimensions

Note: 1. All units are in millimeters unless otherwise indicated.

2. Orientation marks are indicated as follows:  

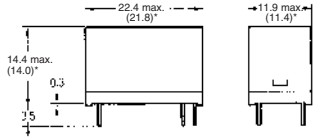
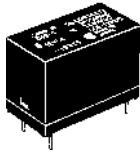

*Average value.

Terminal Arrangement/Internal Connections (Bottom View)

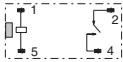

Mounting Holes (Bottom View)

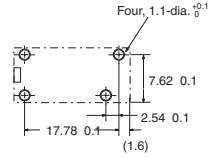

ALL DIMENSIONS SHOWN ARE IN MILLIMETERS.

To convert millimeters into inches, multiply by 0.03937. To convert grams into ounces, multiply by 0.03527.

A Miniature Relay with 1-pole 5 A Switching Capability and 10 kV Impulse Withstand Voltage

- ROHS compliant.
- Highly efficient magnetic circuit for high sensitivity (200 mW).
- Compact, slim, yet provides 10 kV impulse withstand voltage (between coil and contacts).
- Standard model conforms to UL, CSA and EN standards.
- Tracking resistance: CTI>250

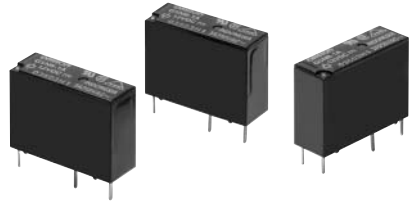

Ordering Information

Classification	Contact form	Enclosure ratings	Model
Standard	SPST-NO	Flux protection	G5NB-1A

Note: When ordering, add the rated coil voltage to the model number.
 Example: G5NB-1A-E 12 VDC



Model Number Legend

G5NB- **-E** **VDC**
 1 2 3

1. Number of Poles

1: 1 pole

2. Contact Form

A: SPST-NO

3. Rated Coil Voltage

5, 12, 18, 24 VDC

Application Examples

Water heaters, refrigerators, air conditioners, and small electric appliances

Specifications

■ Coil Ratings

Rated voltage	5 VDC	12 VDC	18 VDC	24 VDC
Rated current	40.0 mA	16.7 mA	11.1 mA	8.3 mA
Coil resistance	125 Ω	720 Ω	1,620 Ω	2,880 Ω
Must operate voltage	75% max. of rated voltage			
Must release voltage	10% min. of rated voltage			
Max. voltage	170% of rated voltage (at 23°C)			
Power consumption	Approx. 200 mW			

Note: The rated current and coil resistance are measured at a coil temperature of 23°C with a tolerance of ±10%.
The operating characteristics are measured at a coil temperature of 23°C.
The “Max. voltage” is the maximum voltage that can be applied to the relay coil.

■ Contact Ratings

Load	Resistive load ($\cos\phi = 1$)
Rated load	5 A at 250 VAC, 3 A at 30 VDC
Max. switching voltage	250 VAC, 30 VDC
Max. switching current	5 A
Max. switching power	1250 VA, 90 W
Failure rate (reference value)	10 mA at 5 VDC

Note: P level: $\lambda_{60} = 0.1 \times 10^{-6}$ /operation (with an operating frequency of 120 operations/min)

■ Characteristics

Contact resistance (See note 2.)	100 mΩ max.
Operate time	10 ms max.
Release time	10 ms max.
Insulation resistance (See note 3.)	1,000 MΩ min. (at 500 VDC)
Dielectric strength	4,000 VAC, 50/60 Hz for 1 min between coil and contacts 750 VAC, 50/60 Hz for 1 min between contacts of same polarity
Impulse withstand voltage	10,000 V (1.2 x 50 ms) between coil and contacts
Vibration resistance	Destruction: 10 to 55 to 10 Hz, 0.75-mm single amplitude (1.5-mm double amplitude) Malfunction: 10 to 55 to 10 Hz, 0.75-mm single amplitude (1.5-mm double amplitude)
Shock resistance	Destruction: 1,000 m/s ² Malfunction: 100 m/s ²
Endurance	Mechanical: 5,000,000 operations min. Electrical: 100,000 operations min (5 A at 250 VAC), 200,000 operations min. (3 A at 30 VDC)
Failure rate P level (reference value) (See note 4.)	5 VDC, 10 mA
Ambient temperature	Operating: -40°C to 85°C (with no icing or condensation)
Ambient humidity	Operating: 5% to 85%
Weight	Approx. 4 g

Note: 1. The data shown above are initial value.

2. Measurement conditions: 5 VDC, 1 A, voltage drop method.

3. Measurement conditions: Measured at the same points as the dielectric strength using a 500-VDC ohmmeter.

4. This value is for a switching frequency of 120 operations/minute.

■ **Approved Standards**
UL508 (File No. 41515)

Coil ratings	Contact ratings
5 to 24 VDC	5 A, 30 VDC (resistive) 5 A, 125 VAC (resistive) 5 A, 250 VAC (general use)

■ **CSA C22.2 (No. 0, No. 1, No. 14) (File No. LR31928)**

Coil ratings	Contact ratings
5 to 24 VDC	5 A, 30 VDC (resistive) 5 A, 125 VAC (resistive) 5 A, 250 VAC (general use)

■ **EN 61810-1 (VDE Reg No 137575)**

Coil ratings	Contact ratings
5 to 24VDC	5 A, 30 VDC (resistive) 5 A, 250 VAC (general use)

■ **Actual Load Life (Reference Values)**

1. 120-VAC motor and lamp load (2.5-A surge and 0.5-A normal): 250,000 operations min.(at 23°C)
2. 160-VDC valve load (with varistor) (0.24-A): 250,000 operations min.(at 23°C)

Engineering Data

Maximum Switching Capacity

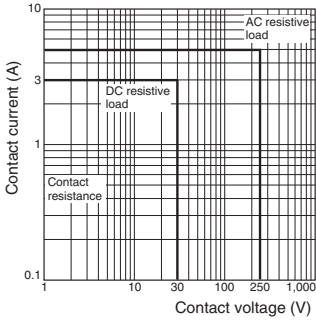

Endurance

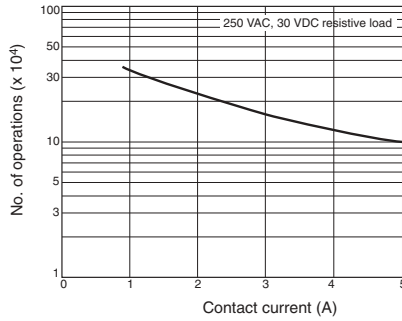

Ambient Temperature vs. Maximum Coil Voltage

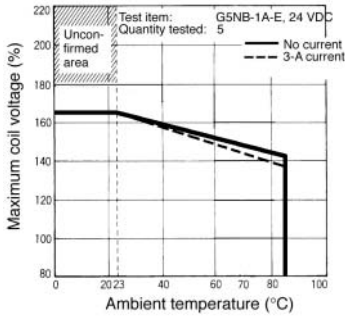

Malfunctioning Shock

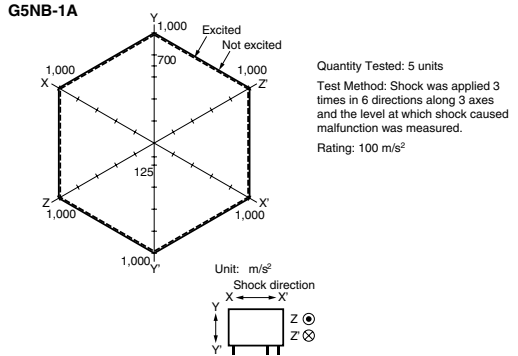

Dimensions

Note: All units are in millimeters unless otherwise indicated.

G5NB-1A-E

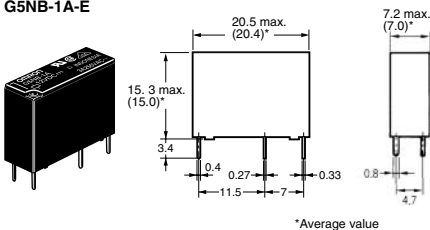

PCB Mounting Holes (Bottom View)

Tolerance: 0.1 mm

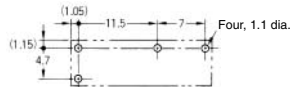

Terminal Arrangement/ Internal Connections (Bottom View)

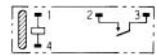

(No coil polarity)

Precautions

■ Correct Use

HANDLING

The enclosure rating of the G5NB is for flux protection. Do not use immersion-cleaning.

ALL DIMENSIONS SHOWN ARE IN MILLIMETERS.

To convert millimeters into inches, multiply by 0.03937. To convert grams into ounces, multiply by 0.03527.

Compact Single-pole Relay for Switching 5 A (Normally Open Contact), Fan Control of Air Conditioners, and Heating Control of Small Appliances.

- ROHS compliant.
- Compact SPDT Relay with high insulation.
- Incorporates a normally open contact that switches 5 A max.
- Ensures a withstand impulse voltage of 8,000 V between the coil and contacts.
- Conforms to UL, CSA and EN.

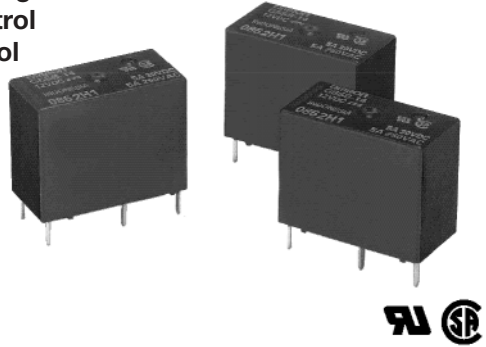

Ordering Information

Classification	Contact form	Enclosure ratings	Model
Standard	SPDT-NO	Fully sealed	G5SB-14

Note: When ordering, add the rated coil voltage to the model number.

Example: G5SB-14 12 VDC

Rated coil voltage

Model Number Legend

G5SB- VDC
1 2 3

1. Number of Poles

1: 1 pole (SPDT)

2. Protective Structure

4: Fully sealed

3. Rated Coil Voltage

5, 9, 12, 24 VDC

Specifications

■ Coil Ratings

Rated voltage	5 VDC	9 VDC	12 VDC	24 VDC
Rated current	80 mA	44.4 mA	33.3 mA	16.7 mA
Coil resistance	63 Ω	202 Ω	360 Ω	1,440 Ω
Must operate voltage	75% max. of rated voltage			
Must release voltage	5% min. of rated voltage			
Max. voltage	110% of rated voltage			
Power consumption	Approx. 400 mW			

■ Contact Ratings

Load	Resistive Load
Rated load	3 A (NO)/3 A (NC) at 125 VAC 5 A (NO)/3 A (NC) at 125 VAC 5 A (NO) at 250 VAC 3 A (NC) at 250 VAC 5 A (NO)/3 A (NC) at 30 VDC
Contact material	Ag alloy
Rated carry current	5 A (NO)/3 A (NC)
Max. switching voltage	250 VAC, 30 VDC
Max. switching current	5 A (NO)/3 A (NC)
Max. switching capacity	1,250 VA, 150 W (NO) 750 VA, 30 W (NC)
Min. permissible load	10 mA at 5 VDC

Note: P level: $\lambda_{60} = 0.1 \times 10^{-9}$ /operation (with an operating frequency of 120 operations/min)

■ Characteristics

Contact resistance (see note 2)	100 mΩ max.
Operate time (see note 3)	10 ms max.
Release time (see note 3)	5 ms max.
Insulation resistance (see note 4)	1,000 MΩ min.
Dielectric strength	4,000 VAC, 50/60 Hz for 1 min between coil and contacts 1,000 VAC, 50/60 Hz for 1 min between contacts of same polarity
Impulse withstand voltage	8 kV (1.2 x 50 μs)
Vibration resistance	Destruction: 10 to 55 Hz, 0.75-mm single amplitude (1.5-mm double amplitude) Malfunction: 10 to 55 Hz, 0.75-mm single amplitude (1.5-mm double amplitude)
Shock resistance	Destruction: 1,000 m/s ² (approx. 100 G) Malfunction: Energized: 100 m/s ² (approx. 10 G) Non-energized: 100 m/s ² (approx. 10 G)
Endurance (see note 5)	Mechanical: 5,000,000 operations (18,000 operations per hour) Electrical: 200,000 operations: 3 A (NO)/3 A (NC) at 125 VAC resistive load 50,000 operations: 5 A (NO)/3 A (NC) at 125 VAC resistive load 50,000 operations: 5 A (NO) at 250 VAC resistive load 10,000 operations: 3 A (NC) at 250 VAC resistive load 10,000 operations: 5 A (NO)/3 A (NC) at 30 VDC resistive load Switching frequency: 1,800 operations per hour
Ambient temperature	Operating: -40°C to 70°C with no icing or condensation
Ambient humidity	Operating: 5% to 95%
Weight	Approx. 6.5 g

Note: 1. The data shown above are initial values.

2. The contact resistance is possible with 1 A applied at 5 VDC using a fall-of-potential method.

3. The operating time is possible with the operating voltage imposed with no contact bounce at an ambient temperature of 23°C.

4. The insulation resistance is possible between coil and contacts and between contacts of the same polarity at 500 VDC.

5. The electrical durability data items shown are possible at 23°C.

■ Approved Standards

UL508 (File No. E41515)/CSA C22.2 (No.14) (File No. LR31928)

EN 61810-1 (VDE Reg. no 40000957)

Model	Coil ratings	Contact ratings
G5SB	5 to 24 VDC	3 A, 125 VAC (resistive) NC only 2 A, 125 VAC (resistive) NC only 5 A, 250 VAC (resistive) NO only 3 A, 250 VAC (resistive) NO only 5 A, 30 VDC (resistive) NO only

Electrical endurance tests are performed at 70°C.

Engineering Data

Max. Switching Capacity

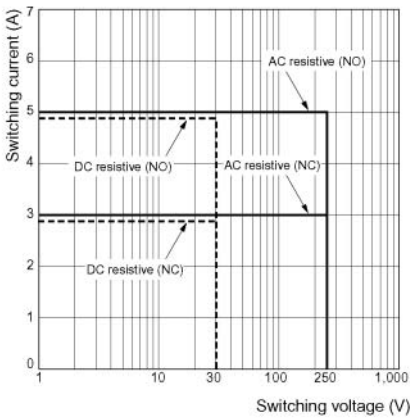

Ambient Temperature vs. Maximum Voltage

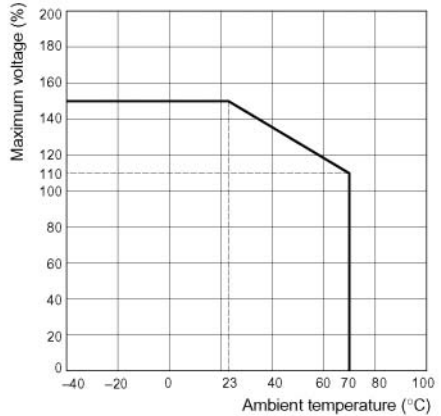

Dimensions

Note: All units are in millimeters unless otherwise indicated.

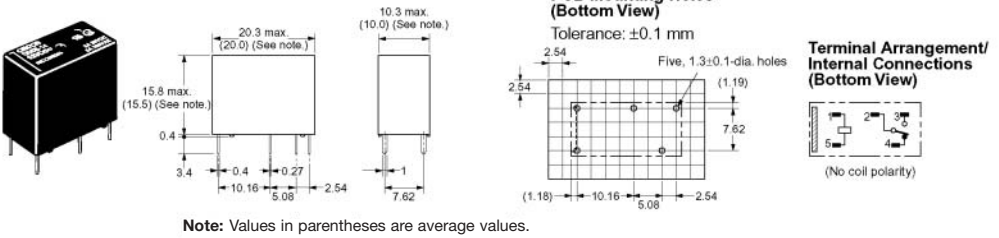

Note: Values in parentheses are average values.

Application Examples

- Fan Motor
- Refrigerator
- Air Conditioner
- Oven
- Washing Machine
- Others

ALL DIMENSIONS SHOWN ARE IN MILLIMETERS.

To convert millimeters into inches, multiply by 0.03937. To convert grams into ounces, multiply by 0.03527.

Slim, Miniature Relay, Capable of Relaying Programmable Controller and Temperature Controller Outputs

- ROHS compliant.
- Slim 5-mm width, and miniature size.
- Reduced mounting area ideal for high-density mounting.
- Highly efficient magnetic circuit for high sensitivity (40% higher than the G6D, with power consumption of 120 mW).
- Satisfies IEC61131-2 and IEC61010 requirements.
- SIL (single-in-line) terminal pitch.
- UL, CSA and EN approved.



Ordering Information

Classification	Contact form	Enclosure ratings	Model
Standard	SPST-NO	Fully sealed	G6M-1A

Note: When ordering, add the rated coil voltage to the model number.

Example: G6M-1A 12 VDC
 └───┬───┘
 Rated coil voltage

Model Number Legend

G6M - VDC
 1 2 3

1. Number of Poles

1: 1 pole

2. Contact Form

A: SPST-NO

3. Rated Coil Voltage

5, 12, 24 VDC

Specifications

■ Coil Ratings

Rated voltage	5 VDC	12 VDC	24 VDC
Rated current	24 mA	10 mA	5 mA
Coil resistance	208 Ω	1,200 Ω	4,800 Ω
Must operate voltage	75% max. of rated voltage		
Must release voltage	5% min. of rated voltage		
Max. voltage	160% of rated voltage (at 23°C)		
Power consumption	Approx. 120 mW		

- Note: 1. The rated current and coil resistance are measured at a coil temperature of 23°C with a tolerance of ±10%.
 2. Operating characteristics are measured at a coil temperature of 23°C.
 3. The maximum allowable voltage is the maximum possible value of the voltage that can be applied to the relay coil. It is not the maximum voltage that can be applied continuously.
 4. The must operate voltage is 72% or less of the rated voltage if the relay is mounted vertically and the terminals are pointed downwards.

■ Contact Ratings

Rated load	3 A at 250 VAC, 3 A at 30 VDC
Rated carry current	5 A
Max. switching voltage	270 VAC, 125 VDC
Max. switching current	5 A
Max. switching power	750 VAC, 90 W
Min. permissible load	10 mA at 5 VDC (at 120 operations/min)

Note: P level: $\lambda_{60} = 0.1 \times 10^{-6}$ /operation

■ Characteristics

Contact resistance	100 mΩ max.
Operate time	10 ms max.
Release time	5 ms max.
Insulation resistance	1,000 MΩ min. (at 500 VDC)
Dielectric strength	3,000 VAC, 50/60 Hz for 1 min between coil and contacts 750 VAC, 50/60 Hz for 1 min between contacts of same polarity
Impulse withstand voltage	5,080 V (1.2 x 50 μs) between coil and contacts
Vibration resistance	Destruction: 10 to 55 Hz, 2.5-mm single amplitude (5.0-mm double amplitude) Malfunction: 10 to 55 Hz, 0.75-mm single amplitude (1.5-mm double amplitude)
Shock resistance	Destruction: 1,000 m/s ² Malfunction: 100 m/s ²
Endurance	Mechanical: 20,000,000 operations min. (at 18,000 operations/hr) Electrical: 100,000 operations min. (3 A at 250 VAC/30 VDC, resistive load)
Ambient temperature	Operating: -40°C to 85°C (with no icing)
Ambient humidity	Operating: 5% to 85%
Weight Approx.	4 g

■ Approved Standards

UL508 (File No. E41515)/CSA C22.2 (No.14) (File No. LR31928)

EN 61810-1 (VDE Reg. no 400003429)

Model	Coil ratings	Contact ratings
G6M-1A	4.5 to 24 VDC	5 A, 250 VAC (resistive load, 6,000 operations) 5 A, 24 VDC (resistive load, 6,000 operations) 3 A, 250 VAC (general use, 100,000 operations) 3A, 24 VDC (general use, 100,000 operations)

Engineering Data

Maximum Switching Power

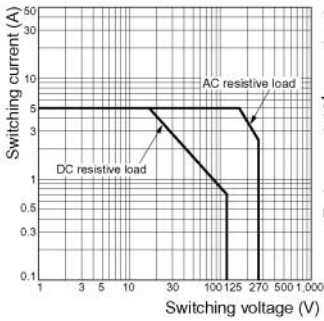

Endurance

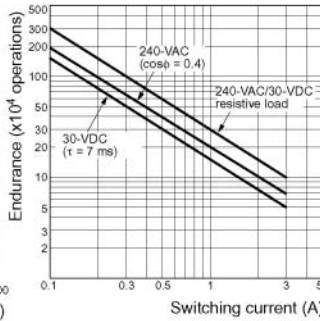

Ambient Temperature vs. Maximum Coil Voltage

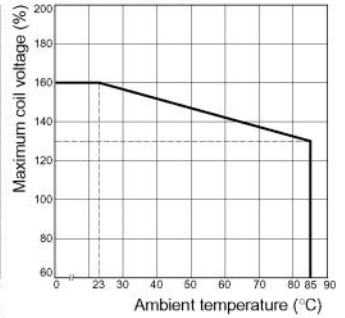

Note: The maximum coil voltage refers to the maximum value in a varying range of operating power voltage, not a continuous voltage.

Dimensions

G6M-1A

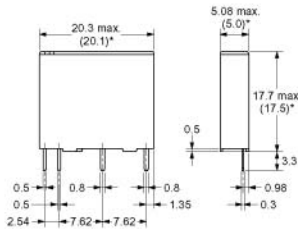

Terminal Arrangement/ Internal Connections (Bottom View)

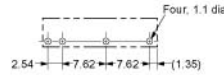

Mounting Holes (Bottom View)

Tolerance: ±0.1



*Average value

Precautions

BASIC INFORMATION

Before actually committing any component to a mass-production situation, OMRON strongly recommends situational testing, in as close to actual production situations as possible. One reason is to confirm that the product will still perform as expected after surviving the many handling and mounting processes involved in mass production. Also, even though OMRON relays are individually tested a number of times, and each meets strict requirements, a certain testing tolerance is permissible. When a high-precision product uses many components, each depends upon the rated performance thresholds of the other components. Thus, the overall performance tolerance may accumulate into undesirable levels.

To avoid problems, always conduct tests under the actual application conditions.

General

To maintain the initial characteristics of a relay, exercise care that it is not dropped or mishandled. For the same reason, do not remove the case of the relay; otherwise, the characteristics may degrade. Avoid using the relay in an atmosphere containing sulfuric acid (SO₂), hydrogen sulfide (H₂S), or other corrosive gases.

Do not continuously apply a voltage higher than the rated maximum voltage to the relay. Never try to operate the relay at a voltage and a current other than those rated.

Do not use the relay at temperatures higher than that specified in the catalog or data sheet.

ALL DIMENSIONS SHOWN ARE IN MILLIMETERS.

To convert millimeters into inches, multiply by 0.03937. To convert grams into ounces, multiply by 0.03527.

Slim, Miniature Relay, Capable of Relaying Programmable Controller and Temperature Controller Outputs

- Slim and miniature: 17.5 x 6.5 x 12.5 mm (L x W x H).
- Reduced bottom area (45% smaller than the G6B's bottom area) ideal for high-density mounting.
- Switches 5 A at 250 VAC/30 VDC.
- Allows 300,000 operations with a 2-A load at 250 VAC or 30 VDC.
- Actual load switching capability equals the G6B's capability.
- Washable construction.

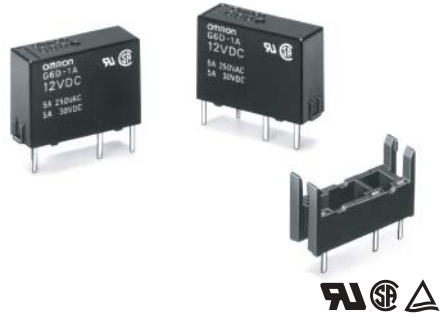

Ordering Information

Classification	Contact form	Enclosure ratings	Model
Standard	SPST-NO	Fully sealed	G6D-1A

Note: When ordering, add the rated coil voltage to the model number.
 Example: G6D-1A 12 VDC

Rated coil voltage

Model Number Legend

G6D - VDC
 1 2 3

- 1. **Number of Poles**
1: 1 pole
- 2. **Contact Form**
A: SPST-NO
- 3. **Rated Coil Voltage**
5, 12, 24 VDC

Accessories (Order Separately)

Connecting Socket	P6D-04P
-------------------	---------

Specifications

Coil Ratings

Rated voltage	5 VDC	12 VDC	24 VDC
Rated current	40 mA	16.7 mA	8.3 mA
Coil resistance	125 Ω	720 Ω	2,880 Ω
Must operate voltage	70% max. of rated voltage		
Must release voltage	10% min. of rated voltage		
Max. voltage	160% of rated voltage		
Power consumption	Approx. 200 mW		

Note: The must operate voltage is 75% or less of the rated voltage if the relay is mounted upside down.

■ Contact Ratings

Rated load	5 A at 250 VAC, 5 A at 30 VDC, resistive load ($\cos\phi=1$)
Contact material	AgCdO (Cd free planned 1 Apr 05)
Rated carry current	5 A
Max. switching voltage	250 VAC, 30 VDC
Max. switching current	5 A
Max. switching power	1,250 VA, 150 W
Failure rate (reference value)	10 mA at 5 VDC

Note: P level: $\lambda_{60} = 0.1 \times 10^{-6}$ /operation.

■ Characteristics

Contact resistance (see note 2)	100 m Ω max.
Operate time	10 ms max.
Release time	5 ms max.
Insulation resistance	1,000 M Ω min. (at 500 VDC)
Dielectric strength	3,000 VAC, 50/60 Hz for 1 min between coil and contacts 750 VAC, 50/60 Hz for 1 min between contacts of same polarity
Impulse withstand voltage	6,000 V (1.2 x 50 μ s) between coil and contacts
Vibration resistance	Destruction: 10 to 55 to 10 Hz, 0.75-mm single amplitude (1.5-mm double amplitude) Malfunction: 10 to 55 to 10 Hz, 0.75-mm single amplitude (1.5-mm double amplitude)
Shock resistance	Destruction: 1,000 m/s ² Malfunction: Energized: 100 m/s ²
Endurance (see note 5)	Mechanical: 20,000,000 operations min. (at 18,000 operations/hr) Electrical: 100,000 operations min. (5 A at 250 VAC/30 VDC, resistive load) 300,000 operations min. (2 A at 250 VAC/30 VDC, resistive load)
Ambient temperature	Operating: -40°C to 70°C (with no icing)
Ambient humidity	Operating: 5% to 85%
Weight	Approx. 3 g

■ Approved Standards

UL508 (File No. E41515)/CSA C22.2 No.14 (File No. LR31928),
DIN EN VDE 0627 (VDE Reg No. 132242)

Model	Coil ratings	Contact Ratings
G6D-1A	5 to 24 VDC	5 A, 250 VAC 5 A, 30 VDC

Engineering Data

Maximum Switching Power

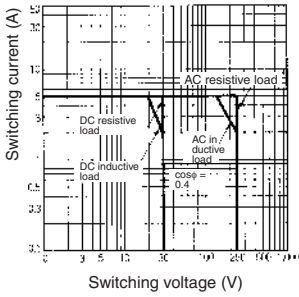

Endurance

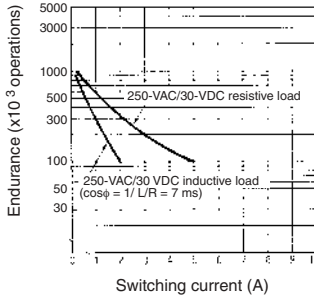

Ambient Temperature vs. Maximum Coil Voltage

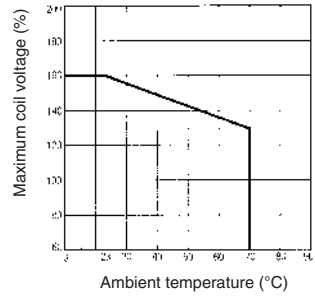

Note: The maximum coil voltage refers to the maximum value in a varying range of operating power voltage, not a continuous voltage.

Reference Data

Electrical Endurance

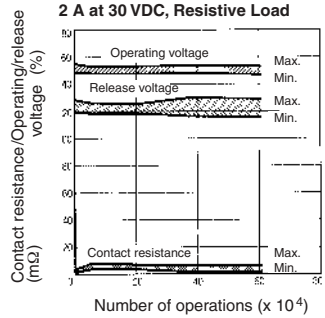
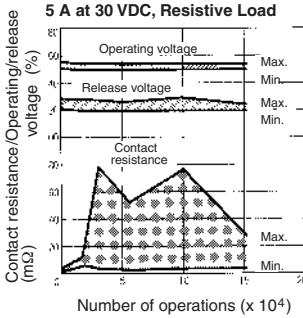
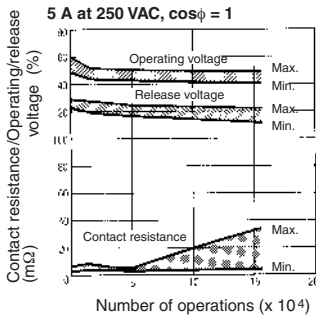

Electrical Endurance

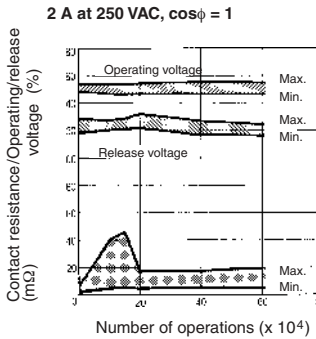

Actual Load Test Data

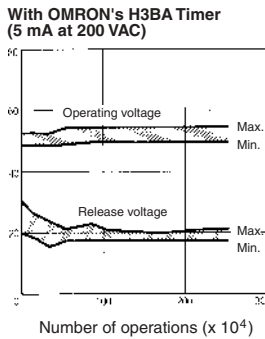

With OMRON's MA415A Contactor (40 mA at 200 VAC)

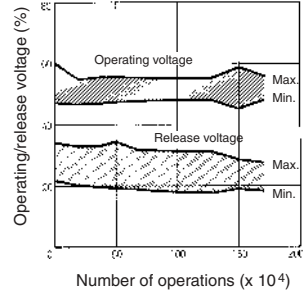

Dimensions

Note: 1. All units are in millimeters unless otherwise indicated.
2. Orientation marks are indicated as follows:

G6D-1A

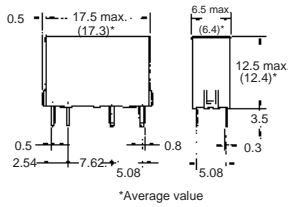
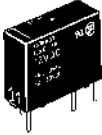

Terminal Arrangement/ Internal Connections (Bottom View)

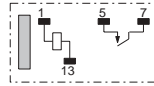

Mounting Holes (Bottom View)

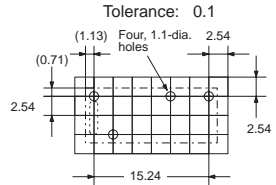

P6D-04P Socket

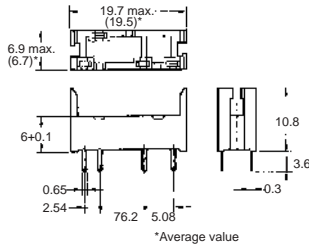
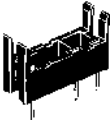

Mounting Holes (Bottom View)

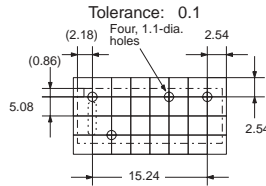

Precautions

More than two relays can be closely mounted right side up as shown in the following illustration.

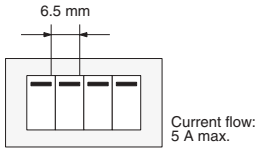

More than two relays can be closely mounted upside down as shown in the following illustration.

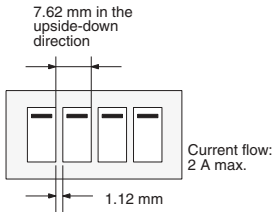

Note: The space between each relay required for heat radiation may vary with operating conditions. Contact your OMRON representative for details

SOCKET MOUNTING HEIGHT

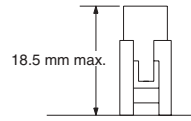

When mounting the relay, insert it into the socket as vertically as possible so that the relay terminals contact securely with the contact pins on the socket.

The P6D is flux-resistant. Do not wash the P6D with water.

Dismount the relay from the socket before soldering the socket to a PCB.

ALL DIMENSIONS SHOWN ARE IN MILLIMETERS.

To convert millimeters into inches, multiply by 0.03937. To convert grams into ounces, multiply by 0.03527.

Sub-miniature Relay that Switches up to 5 A

- Sub-miniature: 20 x 10 x 10 mm (L x W x H).
- Low power consumption: 200 mW.
- Unique moving loop armature reduces relay size, magnetic interference, and contact bounce time.
- Single- and double-winding latching types also available.

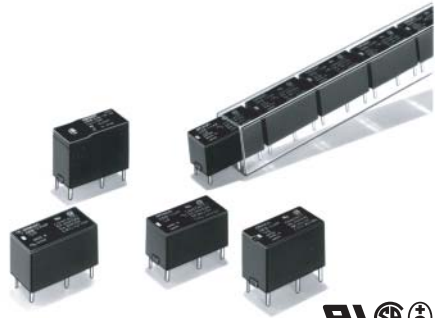

Ordering Information

Classification	Contact form	Straight PCB	Self-clinching PCB
Single-side stable	SPST-NO	G6B-1114P-US	G6B-1114C-US
	SPST-NO+SPST-NC	G6B-2114P-US	G6B-2114C-US
	DPST-NO	G6B-2214P-US	G6B-2214C-US
	DPST-NC	G6B-2014P-US	G6B-2014C-US
Single-winding latching	SPST-NO	G6BU-1114P-US	G6BU-1114C-US
Double-winding latching	SPST-NO	G6BK-1114P-US	G6BK-1114C-US
High-capacity single-side stable	SPST-NO	G6B-1174P-US	G6B-1174C-US

Note: When ordering, add the rated coil voltage to the model number.

Example: G6B-1114P-US 12 VDC

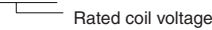

Model Number Legend

G6B - - VDC
 1 2 3 4 5 6 7

1. Relay Function

- None: Single-side stable
- U: Single-winding latching
- K: Double-winding latching

2. Contact Form

- 21: SPST-NO + SPST-NC
- 22: DPST-NO
- 20: DPST-NC
- 11: SPST-NO

3. Contact Type

- 1: Standard
- 7: High-capacity

4. Enclosure Ratings

- 4: Fully sealed

5. Terminals

- P: Straight PCB
- C: Self-clinching PCB

6. Approved Standards

- US: UL/CSA certified

7. Rated Coil Voltage

- 5, 6, 12, 24 VDC

Accessories (Order Separately)

Back Connecting Sockets

Applicable relay	Back connecting socket*
G6B(U)-1114P-US	P6B-04P
G6BK-1114P-US	P6B-06P
G6B-2114P-US	P6B-26P
G6B-1174P-US	P6B-04P

Removal Tool	P6B-Y1
Hold-down Clips	P6B-C2

*Not applicable to the self-clinching type.

Specifications

■ Coil Ratings

Single-side Stable Type

Item		SPST-NO					SPST-NO + SPST-NC, DPST-NO, DPST-NC				
Rated voltage		3 VDC	5 VDC	6 VDC	12 VDC	24 VDC	3 VDC	5 VDC	6 VDC	12 VDC	24 VDC
Rated current		67 mA	40 mA	33.3 mA	16.7 mA	8.3 mA	100 mA	60 mA	50 mA	25 v	12.5 mA
Coil resistance		45 Ω	125 Ω	180 Ω	720 Ω	2,880 Ω	30 Ω	83.3 Ω	120 Ω	480 Ω	1,920 Ω
Coil inductance (H) (ref. value)	Armature OFF	0.20	0.28	0.31	1.2	4.9	–	–	–	–	–
	Armature ON	0.18	0.26	0.28	1.1	4.1	–	–	–	–	–
Must operate voltage		70% max. of rated voltage					80% max. of rated voltage				
Must release voltage		10% min. of rated voltage									
Max. voltage		160% of rated voltage (at 23°C)					140% of rated voltage (at 23°C)				
Power consumption		Approx. 200 mW					Approx. 300 mW				

Single-winding Latching Type

Rated voltage		3 VDC	5 VDC	6 VDC	12 VDC	24 VDC
Rated current		67 mA	40 mA	33.3 mA	16.7 mA	8.3 mA
Coil resistance		45 Ω	125 Ω	180 Ω	720 Ω	2,880 Ω
Coil inductance (H) (ref. value)	Armature OFF	0.20	0.28	0.31	1.2	4.9
	Armature ON	0.18	0.26	0.28	1.1	4.1
Must operate voltage		70% max. of rated voltage				
Must release voltage		70% min. of rated voltage				
Max. voltage		160% of rated voltage (at 23°C)				
Power consumption		Approx. 200 mW				

Double-winding Latching Type

Rated voltage		3 VDC	5 VDC	6 VDC	12 VDC	24 VDC	
Set coil	Rated current	93.2 mA	56 mA	46.8 mA	23.3 mA	11.7 mA	
	Coil resistance	32.2 Ω	89.2 Ω	128.5 Ω	515 Ω	2,060 Ω	
	Coil inductance (H) (ref. value)	Armature OFF	0.11	0.15	0.18	0.52	1.2
		Armature ON	0.11	0.15	0.18	0.52	1.2
Reset coil	Rated current	93.2 mA	56 mA	46.8 mA	23.3 mA	11.7 mA	
	Coil resistance	32.2 Ω	89.2 Ω	128.5 Ω	515 Ω	2,060 Ω	
	Coil inductance (H) (ref. value)	Armature OFF	0.11	0.15	0.18	0.52	1.2
		Armature ON	0.11	0.15	0.18	0.52	1.2
Must set voltage		70% max. of rated voltage					
Must reset voltage		70% min. of rated voltage					
Max. voltage		130% of rated voltage (at 23°C)					
Power consumption		Set coil: Approx. 280 mW Reset coil: Approx. 280 mW					

Note: 1. The rated current and coil resistance are measured at a coil temperature of 23°C with a tolerance of ±10%.
2. Operating characteristics are measured at a coil temperature of 23°C.

■ Contact Ratings

Item	SPST-NO		SPST-NO + SPST-NC, DPST-NO, DPST-NC	
	Resistive load ($\cos\phi = 1$)	Inductive load ($\cos\phi = 0.4$; L/R = 7 ms)	Resistive load ($\cos\phi = 1$)	Inductive load ($\cos\phi = 0.4$; L/R = 7 ms)
Rated load	5 A at 250 VAC; 5 A at 30 VDC	2 A at 250 VAC; 2 A at 30 VDC	5 A at 250 VAC; 5 A at 30 VDC	1.5 A at 250 VAC; 1.5 A at 30 VDC
Contact material	AgCdO (Cd free planned 1 Apr 05)			
Rated carry current	5 A			
Max. switching voltage	380 VAC, 125 VDC			
Max. switching current	5 A			
Max. switching power	1,250 VA, 150 W	500 VA, 60 W	1,250 VA, 150 W	375 VA, 80 W
Failure rate (reference value)	10 mA at 5 VDC			

Item	SPST-NO (High-capacity)	
	Resistive load ($\cos\phi = 1$)	Inductive load ($\cos\phi = 0.4$; L/R = 7 ms)
Rated load	8 A at 250 VAC; 5 A at 30 VDC	2 A at 250 VAC; 2 A at 30 VDC
Contact material	AgCdO	
Rated carry current	8 A	
Max. switching voltage	380 VAC, 125 VDC	
Max. switching current	8 A	
Max. switching power	2,000 VA, 150 W	
Failure rate (reference value)	10 mA at 5 VDC	

Note: P level: $\lambda_{60} = 0.1 \times 10^{-6}$ /operation

■ Characteristics

Contact resistance	30 m Ω max.
Operate (set) time	10 ms max. (mean value: 1-pole approx. 3 ms, 2-pole approx. 4 ms)
Release (reset) time	Single-side stable types: 10 ms max. (mean value: 1-pole approx. 1 ms, 2-pole approx. 2 ms) Latching types: 10 ms max. (mean value: approx. 3 ms)
Min. set/reset signal width	Latching type: 15 ms min. (at 23°C)
Max. operating frequency	Mechanical: 18,000 operations/hr Electrical: 1,800 operations/hr (under rated load)
Insulation resistance	1,000 M Ω min. (at 500 VDC, at 250 VDC between set coil and reset coil)
Dielectric strength	3,000 VAC (Latching types: 2,000 VAC), 50/60 Hz for 1 min between coil and contacts 1,000 VAC, 50/60 Hz for 1 min between contacts of same polarity 250 VAC, 50/60 Hz for 1 min between set and reset coils 2,000 VAC, 50/60 Hz for 1 min between contacts of different polarity
Vibration resistance	Destruction: 10 to 55 to 10 Hz, 0.75mm single amplitude (1.5mm double amplitude) Malfunction: 10 to 55 to 10 Hz, 0.75mm single amplitude (1.5mm double amplitude)
Shock resistance	Destruction: 1,000 m/s ² Malfunction: Single-side stable: 100 m/s ² ; Latching: 300 m/s ²
Endurance	Mechanical: 50,000,000 operations min. (at 18,000 operations/hr) Electrical: 100,000 operation min. (at 1,800 operations/hr)
Ambient temperature	Operating: -25°C to 70°C (with no icing)
Ambient humidity	Operating: 5% to 85%
Weight	Double-winding latching: Approx. 3.7 g High-capacity: Approx. 4.6 g Double pole: Approx. 4.5 g Other: Approx. 3.5 g

Note: The data shown above are initial values.

■ Approved Standards

UL508 (File No. E41643)/CSA C22.2 No.14 (File No. LR31928)

EN 61810-1 (VDE Reg No. 5361)/Connector EN 61984 (VDE Reg No. 125603)

Model	Contact form	Coil ratings	Contact ratings
G6B-1114P-US G6B-1114C-US G6BU-1114P-US G6BU-1114C-US G6BK-1114P-US G6BK-1114C-US	SPST-NO	3 to 24 VDC	5 A, 250 VAC (general use) 5 A, 30 VDC (resistive load)
G6B-1174P-US G6B-1174C-US			8 A, 250 VAC (general use) 8 A, 30 VDC (resistive load)
G6B-2114P-US G6B-2114C-US G6B-2214P-US G6B-2214C-US G6B-2014P-US G6B-2014C-US	SPST-NO + SPST-NC DPST-NO DPST-NC		5 A, 250 VAC (general use) 5 A, 30 VDC (resistive load)

Engineering Data

G6B-1114P-US

Maximum Switching Power

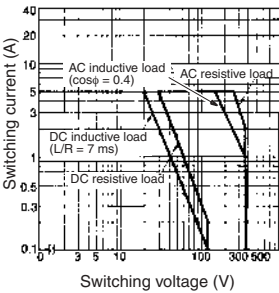

Endurance

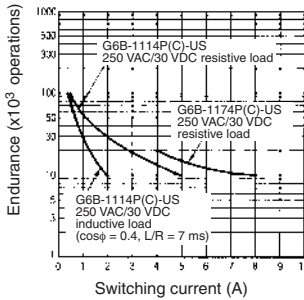

Ambient Temperature vs. Maximum Coil Voltage

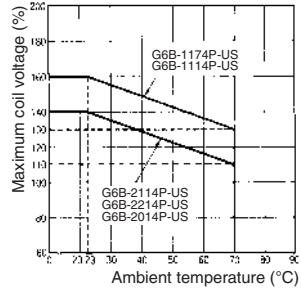

Note: The maximum coil voltage refers to the maximum value in a varying range of operating power voltage, not a continuous voltage.

G6B-2114P-US, G6B-2214P-US

G6B-2014P-US

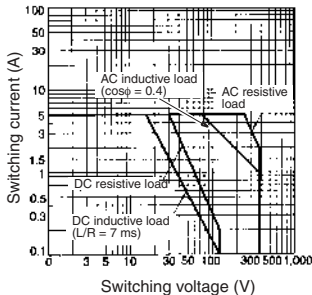

Maximum Switching Power

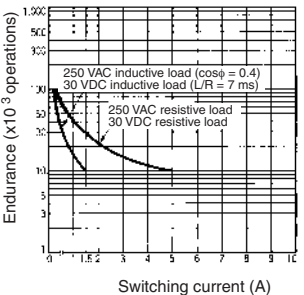

Endurance



Dimensions

Note: 1. All units are in millimeters unless otherwise indicated.
 2. Orientation marks are indicated as follows:  

G6B-1114P-US
G6BU-1114P-US

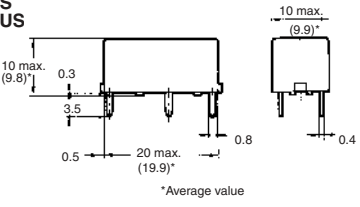

Terminal Arrangement/Internal Connections (Bottom View)
G6B-1114P, -1114C

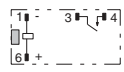

Mounting Holes (Bottom View)
G6B-1114P, -1114C
G6BU-1114P, -1114C

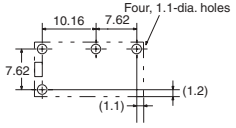

G6B-1114C-US
G6BU-1114C-US

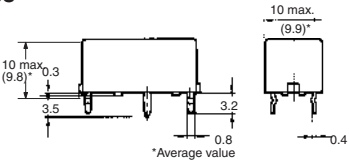

G6BU-1114P, -1114C

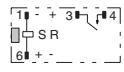

G6BK-1114P-US

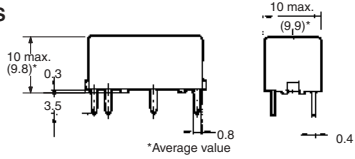
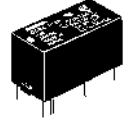

Terminal Arrangement/Internal Connections (Bottom View)
G6BK-1114P, -1114C

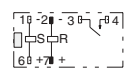

Mounting Holes (Bottom View)
G6BK-1114P, -1114C

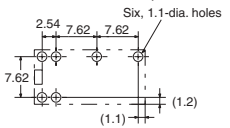

G6BK-1114C-US

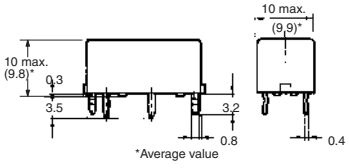
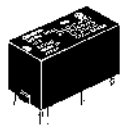

G6B-1174P-US

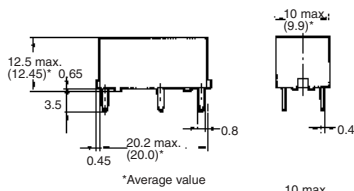
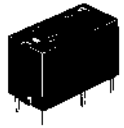

Terminal Arrangement/Internal Connections (Bottom View)
G6B-1174P, -1174C

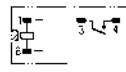

Mounting Holes (Bottom View)

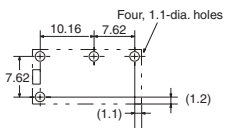

G6B-1174C-US

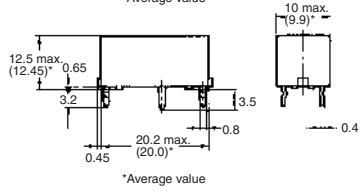
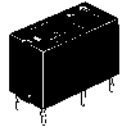

G6B-2114P-US
G6B-2214P-US
G6B-2014P-US

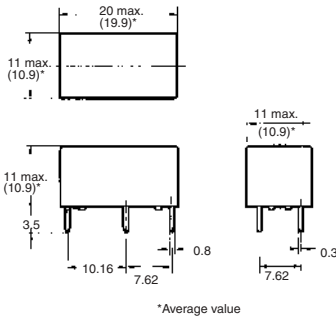
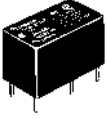

Terminal Arrangement/Internal Connections (Bottom View)

G6B-2114P-US

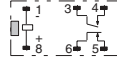

G6B-2214P-US

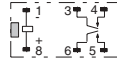

G6B-2014P-US

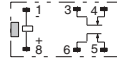

Mounting Holes (Bottom View)
Tolerance: 0.1

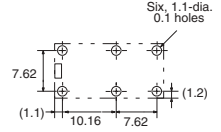

G6B-2114C-US
G6B-2214C-US
G6B-2014C-US

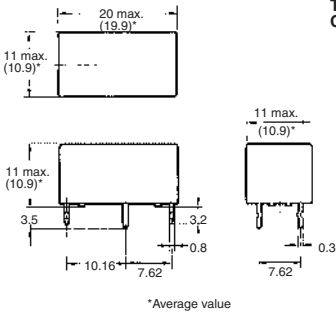
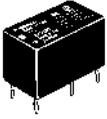

Terminal Arrangement/Internal Connections (Bottom View)

G6B-2114C-US

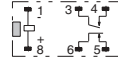

G6B-2214C-US

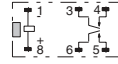

G6B-2014C-US

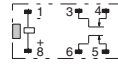

Mounting Holes (Bottom View)
Tolerance: 0.1

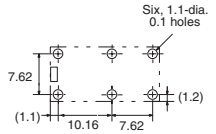

Back Connecting Socket
P6B-04P

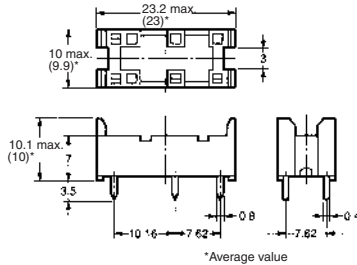
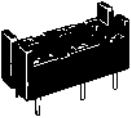

Mounting Holes (Bottom View)

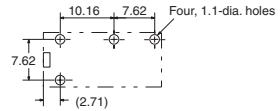

P6B-06P

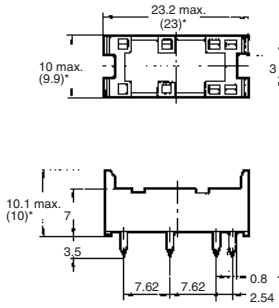
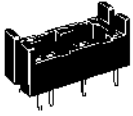

Mounting Holes (Bottom View)

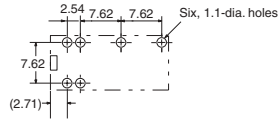

*Average value

P6B-26P

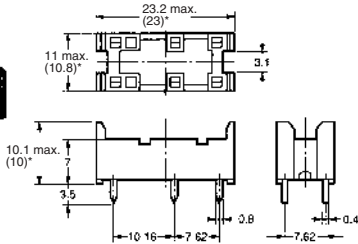
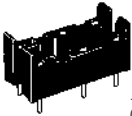

Mounting Holes (Bottom View)

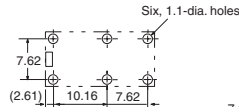

Note: Rated current of socket is 5 A max.

Mounting Height of Relay with Connecting Socket

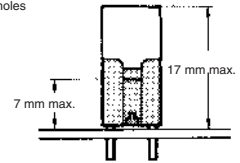

Note: Height of G6B-1174P-US is 19.5 mm max.

*Average value

**Removal Tool
P6B-Y1**

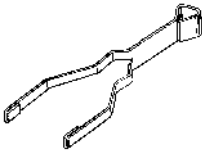

**Hold-down Clips
P6B-C2**



Note: P6B-C2 Hold-down Clips cannot be used for G6B-1174P-US.

ALL DIMENSIONS SHOWN ARE IN MILLIMETERS.

To convert millimeters into inches, multiply by 0.03937. To convert grams into ounces, multiply by 0.03527.

Power Relay with 1.5mm Contact Gap

- ROHS compliant.
- Clearance between contact terminals of the same polarity: 1.5 mm min.
- Meets the requirements of European UPS standards.
Note:UPS: Uninterruptible power systems.
- Conforms to EN 61810-1, UL508, CSA22.2.
- Meets VDE0700 requirements for household products according to VDE0110.
- Tracking resistance: CTI > 250 V.



Ordering Information

Contact form	Rated coil voltage	Model number
DPST-NO	12 VDC 24 VDC	G2RG-2A4

Model Number Legend

G2RG-□□□
1 2 3

1. Number of Poles

2: 2 poles

2. Contact Form

A: N.O. contact

3. Protective Structure

4: Plastic sealing

Specifications

■ Coil Ratings

Rated voltage	Rated current	Coil resistance	Must-operate voltage	Must-release Voltage	Maximum allowable voltage	Power consumption
12 VDC	66.6 mA	180 Ω	80% max.	10% min.	140% (at 23°C)	Approx. 800 mW
24 VDC	33.3 mA	720 Ω				

- Note:** 1. The rated current and coil resistance are for a coil temperature of 23°C and have a tolerance of ±10%.
 2. The operating characteristics given in the above table are for a coil temperature of 23°C.
 3. The maximum allowable voltage is the maximum possible value of the voltage that can be applied to the relay coil.

■ Contact Ratings

Load	Resistive load
Contact mechanism	Single
Contact material	Ag alloy
Rated load	250 VAC, 8 A
Rated carry current	8 A
Maximum switching voltage	380 VAC, 125 VDC
Maximum switching current	8 A
Failure rate (P level, reference value) (See note.)	5 VDC, 10 mA

Note: This value is for a switching frequency of 120 operations/min.

■ Characteristics

Contact resistance (See note 1.)	100 mΩ max.	
Operate time	15 ms max.	
Release time	5 ms max.	
Maximum switching frequency	Mechanical	18,000 operations/hr
	Electrical	1,800 operations/hr (under rated load)
Insulation resistance (See note 2.)	1,000 MΩ min. (at 500 VDC)	
Dielectric strength	5,000 VAC, 50/60 Hz for 1 min between coil and contacts 3,000 VAC, 50/60 Hz for 1 min between contacts of different polarity 1,000 VAC, 50/60 Hz for 1 min between contacts of the same polarity	
Impulse withstand voltage	10 kV (1.2 × 50 μs)	
Vibration resistance	Destruction	10 to 55 to 10 Hz, 0.75-mm single amplitude (1.5-mm double amplitude)
	Malfunction	10 to 55 to 10 Hz, 0.75-mm single amplitude (1.5-mm double amplitude)
Shock resistance	Destruction	1,000 m/s ²
	Malfunction	200 m/s ² when energized
Endurance	Mechanical	1,000,000 operations min. (at 18,000 operations/hr)
	Electrical	10,000 operations min. (at 1,800 operations/hr under rated load)
Ambient operating temperature	-40 to 70 °C (with no icing or condensation)	
Ambient operating humidity	5% to 85%	
Weight	Approx. 17.2 g	

Note 1. The above values are initial values (at an ambient temperature of 23°C.)

2. Measurement conditions: 5 VDC, 1 A, voltage-drop method.

3. Measurement conditions: Measured with a 500-VDC megohmmeter at the same places as the dielectric strength.

■ Approved Standards

The approved rated values for international standards are different to the individually specified characteristic values. Be sure to confirm that required standards are satisfied before actual use.

UL508 (File No. E41643)

Model	Contact form	Coil rating	Contact rating
G2RG-2A4	DPST-NO	12 to 24 VDC	8 A, 250 VAC (general use)

CSA C22.2 No. 14 (File No. LR31928)

Model	Contact form	Coil rating	Contact rating
G2RG-2A4	DPST-NO	12 to 24 VDC	8 A, 250 VAC (general use)

EN 61810-1 (VDE Reg No. 6166)

Model	Contact form	Coil rating	Contact rating
G2RG-2A4	DPST-NO	12, 24 VDC	8 A, 250 VAC (cosφ = 1)

Engineering Data

Maximum Switching Capacity

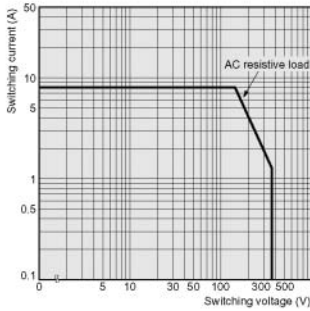

Ambient Temperature vs Maximum Allowable Voltage

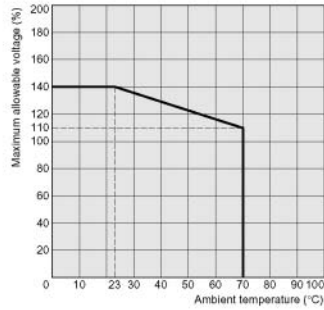

Note: The maximum allowable voltage is the maximum possible value of the voltage that can be applied to the relay coil.

Dimensions

G2RG-2A4

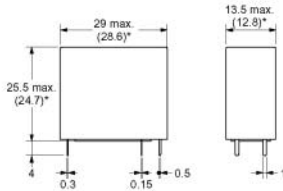

*Figures in parentheses indicate average values.

PCB Mounting Holes (Bottom View)

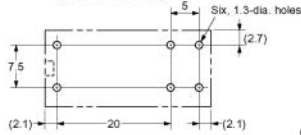

Terminal Arrangement/ Internal Connections (Bottom View)



(The coil has no polarity.)

Precautions

■ Correct Use

Differences with the G2R

The G2RG-2A4 has the same terminal arrangement as the G2R-2A4 but the switching capacity and electrical endurance are different. Confirm that correct operation is possible in the actual operating conditions before using in applications.

ALL DIMENSIONS SHOWN ARE IN MILLIMETERS.

To convert millimeters into inches, multiply by 0.03937. To convert grams into ounces, multiply by 0.03527.

Compact, High Isolation Relay

- ROHS compliant.
- Compact single pole relay with high isolation between coil and contacts.
- Up to 10 A 250 VAC switching on the NO contacts.
- Ensures a withstand impulse voltage of 8,000 V between the coil and contacts.
- Low coil power consumption (SPST-NO: 200 mW, SPDT: 400 mW).
- UL class F coil insulation.
- UL, CSA and EN approvals.
- Ideal for appliance and HVAC controls.
- Tracking resistance: CTI > 250.



Ordering Information

To Order: Select the part number and add the desired coil voltage rating (e.g. G5Q-14-EU-DC12)

Classification		Enclosure rating	Part number
Single contact, Class F coil	SPST-NO	Vented	G5Q-1A-EU
		Sealed	G5Q-1A4-EU
	SPDT	Vented	G5Q-1-EU
		Sealed	G5Q-14-EU

Specifications

■ Coil Ratings

Rated voltage (V)		Rated current	Coil resistance (Ω)	Pick-up voltage	Drop-out Voltage	Maximum voltage	Power consumption (mW)
SPDT	DC5	80	63	75% of max.	5% of max.	190% at 23°C	400
	DC12	33.3	360				
	DC24	16.7	1440				
SPST-NO	DC5	40	125	75% of max.	5% of max.	190% at 23°C	200
	DC12	16.7	720				
	DC24	8.3	2880				

Note: Rated current and coil resistance are measured at 23C with a tolerance of 10%.

■ Contact Ratings

Load	SPDT	SPDT-NO
Rated load (resistive)	10A at 250 VAC (NO) 3A at 250 VAC (NO) 3A at 125 VAC (NO) 5A at 30 VDC (NO) 3A at 250 VDC (NC) 3A at 125 VDC (NC) 3A at 30 VDC (NC)	10A at 250 VAC 3A at 250 VAC 3A at 125 VAC 5A at 30 VDC
Contact material	Ag Alloy	
Rated carry current	AC 10 A – DC 5A (NO)/ AC 3A – DC 3A (NC)	
Max. switching voltage	277 VAC, 30 VDC	
Max. switching current	AC: 10 A (NO)/3 A (NC) DC: 5 A (NO)/3 A (NC)	
Max. switching capacity	2500 VA, 150 W (NO) 750 VA, 90 W (NC)	
Min. permissible load	10 mA at 5 VDC (P level: $\lambda 60 = 0.1 \times 10^{-6}$ operation)	

■ Characteristics

Contact resistance (see note 2)	100 m Ω max.
Operate time	10 ms max.
Release time	5 ms max.
Insulation resistance (see note 3)	1,000 M Ω min.
Dielectric strength	4,000 VAC, 50/60 Hz for 1 min between coil and contacts 1000 VAC, 50/60 Hz for 1 min between contacts of same polarity
Impulse withstand voltage	8 kV (1.2 x 50 ms) between coil and contacts
Vibration resistance	Destruction: 10 to 55 Hz, 1.5-mm double amplitude for 2 hours Malfunction: 10 to 55 Hz, 1.5-mm double amplitude for 5 minutes
Shock resistance	Destruction: 1,000 m/s ² (approx. 100G) Malfunction: 100 m/s ² (approximately 10G)
Life expectancy (see note 4)	Mechanical 10,000,000 operations (18,000 operations per hour) Electrical 200,000 operations: 3 A (NO)/3 A (NC) at 125 VAC resistive load 100,000 operations: 3 A (NO)/3 A (NC) at 250 VAC 5 A (NO)/3 A (NC) at 30 VDC resistive load 25,000 operations: 10A (NO) at 250 VAC (900 operations per hour: 1 sec ON/3 sec OFF) Switching frequency: 1,800 operations per hour: 1 sec ON/1 SEC OFF
Ambient temperature	Operating & storage: -40°C to 85°C (with no icing)
Ambient humidity	Operating & storage: 5% to 85%

Note: 1. The data shown above are initial value.

2. The contact resistance is possible with 1 A applied at 5 VDC using a fall-of-potential method.

3. The insulation resistance is possible between coil and contacts and between contacts of the same polarity at 500 VDC.

4. The electrical life data items shown are possible at 23°C.

■ UL508 (File No. E41515)
 CSA C22.2 No. 14 (File No. LR31928)

Model	Coil ratings	Contact ratings	
		NO contacts	NC contacts
G5Q-EU	5-48 VDC	10 A, 250 VAC resistive 10 A, 30 VDC resistive 4 A, 120 VAC resistive, 100,000 ops. 4 FLA, 4 LRA 120 VAC, definite purpose, 100,000 operations.	3 A, 250 VAC resistive 3 A, 30 VDC resistive 4 LRA, 2 FLA, 120 VAC definite purpose, 100,000 operations.

Note: Ratings for both NO contacts and NC contacts are given at 105°C (221°F).

EN 61810-1 (VDE Reg. no 125314)

Model	Coil ratings	Contact ratings
G5Q-EU	5,12, 24 VDC	10 A, 250 VAC 5 A, 30 VDC (NO) 3 A, 250 VDC (NC)

Engineering Data

■ AMBIENT TEMPERATURE VS. MAXIMUM VOLTAGE

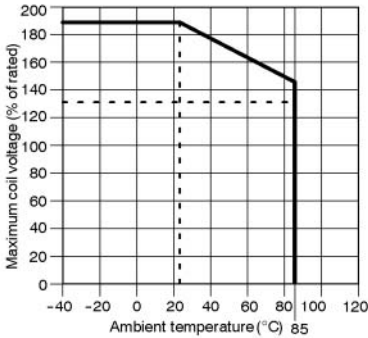

■ AMBIENT TEMPERATURE VS. RATED CARRY CURRENT

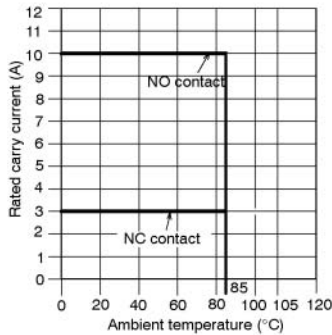

■ MAX. SWITCHING CAPACITY

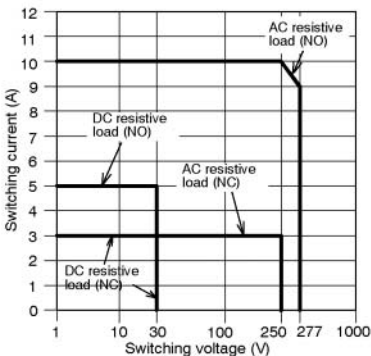

Dimensions

Note: All units are in millimeters unless otherwise indicated.

■ G5Q-EU SPDT

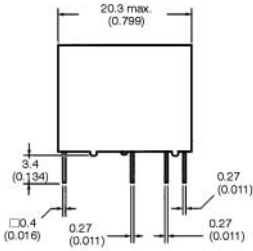

PCB Mounting Holes
(Bottom View)
Tolerance: ± 0.1 mm

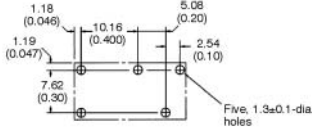

Terminal Arrangement/
Internal Connections
(Bottom View)

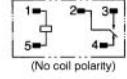

■ SPST-NO

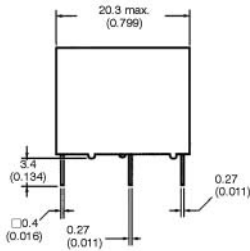

PCB Mounting Holes
(Bottom View)
Tolerance: ± 0.1 mm

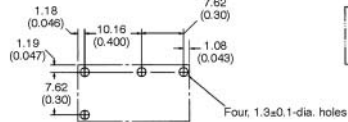

Terminal Arrangement/
Internal Connections
(Bottom View)

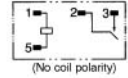

Precautions



CAUTION

Do not touch the terminals of the relay or the charted part of the socket when power is supplied to the Relay. Otherwise, an electric shock may occur.

ALL DIMENSIONS SHOWN ARE IN MILLIMETERS.

To convert millimeters into inches, multiply by 0.03937. To convert grams into ounces, multiply by 0.03527.

Heavy-duty Miniature Relay

- ROHS compliant.
- Incorporates environment-friendly, cadmium-free contacts.
- Variety of contact forms: SPDT or SPST-NO (continuous current rating: 8 A)
- Dielectric strength of 4 kV at a distance of 8 mm.
- Tracking resistance: CTI>250
- Conforms to EN 61810-1.

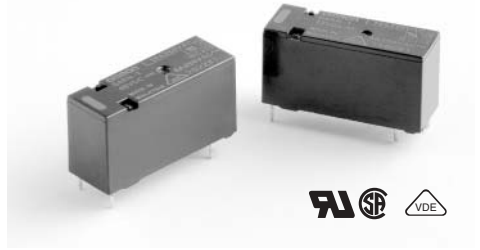

Ordering Information

Classification	Enclosure ratings	Contact material	Contact form	
			SPST-NO	SPDT
Standard	Fully sealed	AgNi + gold plating (0.35 μ)	G6RN-1A	G6RN-1
		AgNi + gold plating (4 μ)	G6RN-1A-AP4	G6RN-1-AP4

Note: When ordering, add the rated coil voltage to the model number.

Example: G6RN-1A 24VDC
 Rated coil voltage

Model Number Legend

G6RN-□□-□□ VDC
 1 2 3 4

1. Number of Poles

1: 1 pole

2. Contact Form

None: SPDT
 A: SPST-NO

3. Contact Material

None: AgNi + gold plating (0.35 μ)
 ANI: AgNi
 AP4: AgNi + gold plating (4 μ)

4. Rated Coil Voltage

5, 12, 24, 48 VDC

Specifications

■ Coil Ratings

Rated voltage	5 VDC	12 VDC	24 VDC	48 VDC
Rated current	44 mA	18.3 mA	9.2 mA	5.2 mA
Coil resistance	114 Ω	655 Ω	2,620 Ω	9,210 Ω
Must operate voltage	70% max. of rated voltage			
Must release voltage	10% min. of rated voltage			
Max. voltage	110% of rated voltage at max. temperature (at 85°C)			
Power consumption	Approx. 220 mW		Approx. 250 mW	

Note: 1. The rated current and coil resistance are measured at a coil temperature of 23°C with a tolerance of ±10%.
2. Operating characteristics are measured at a coil temperature of 23°C..

■ Contact Ratings

Load	Resistance load ($\cos\phi = 1$)
Rated load	8 A at 250 VAC; 5 A at 30 VDC
Rated carry current	8 A
Max. switching voltage	250 VAC; 30 VDC, (400 VAC) (see note)
Max. switching current	AC 8 A; DC 5 A
Max. switching power	2,000 VA; 150 W
Failure rate (reference value)	5 VDC 10 mA (for gold plating 0.35 μ min.)

Note: Electrical life expectancy is reduced.

■ Characteristics

Operate time	Approx. 6 ms
Release time	Approx. 3 ms
Max. operating frequency	Mechanical: 36,000 operations/hr Electrical: 360 operations/hr (under rated load)
Insulation resistance	1,000 MΩ min. (at 500 VDC)
Dielectric strength	4,000 VAC between coil and contacts 1,000 VAC between contacts
Creepage/clearance	8 mm min. between coil and contacts
Vibration resistance	Malfunction: NO: 10 to 55 to 10 Hz, 0.75mm single amplitude (1.5mm double amplitude) NC: 10 to 55 to 10 Hz, 0.4mm single amplitude (0.8mm double amplitude)
Shock resistance	Destruction: 1,000 m/s ²
Endurance	Mechanical: 10,000,000 operations min. Electrical: Approx. 100,000 operations
Ambient temperature	Operating: -40°C to 85°C (with no icing)
Ambient humidity	Operating: 5% to 85%
Weight	Approx. 9 g
Protection class	II according to VDE0106 Part 1
Insulation class	C/250, B/380 according to VDE0110

■ Approved Standards

EC255 (Includes Reinforced Insulation and Spacing Requirements According to IEC65, 335-1, 950, EN60335-1, 60950)

Standard	Contact form	Coil ratings	Contact rating	Conditions
IEC255-1-00 IEC255-0-20	SPDT SPST-NO	5, 6, 12, 18, 24 36, 48 VDC	8A at 250 VAC (cosφ = 1) (see note)	Pollution: degree: 3 Overvoltage category: II Operating range: class 1 Pick-up class: class C Ambient temperature: -40°C to 85°C

■ EN 61810-1 (VDE Reg. no 0435 part no 201 & 102/Reg. no 6135)

Standard	Contact form	Coil ratings	Contact rating	Conditions
VDE0435 Part201 VDE0435 Part120 EN 61810	SPDT SPST-NO	5, 6, 12, 18, 24 36, 48 VDC	8 A at 250 VAC (cosφ = 1)	Insulation group according to VDE0110 C/250, B/380 Operating range: class 1 Pick-up class: class C Ambient temperature: -40°C to 85°C

■ UL508 (File No. E41515)

Coil ratings	Contact ratings
5 to 48 VDC	10 A at 250 VAC (resistive) 5 A at 30 VDC (resistive) 8 A at 250 VAC (resistive) (ambient temperature: 85°C)

■ CSA C22.2 (File No. LR31928-543)

Coil ratings	Contact ratings
5 to 48 VDC	10 A at 250 VAC (resistive) 5 A at 30 VDC (resistive) 8 A at 250 VAC (resistive) (ambient temperature: 85°C)

Engineering Data

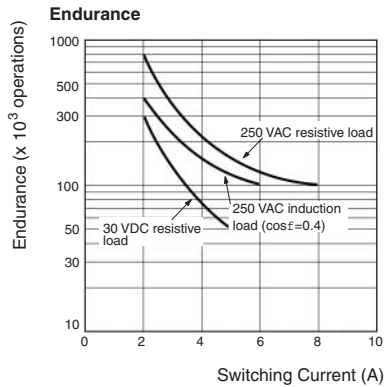
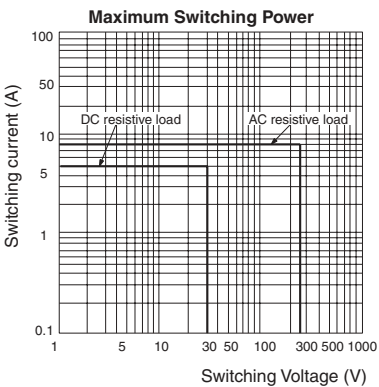

Engineering Data

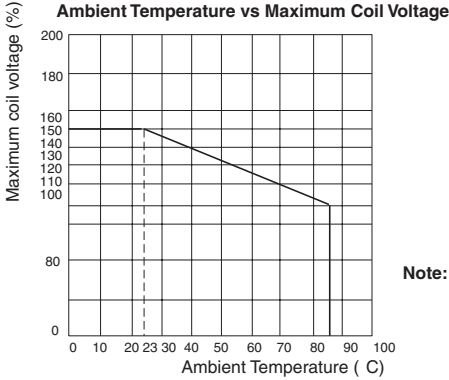

Note: The maximum coil voltage refers to the maximum value in a varying range of operating power voltage, not a continuous voltage.

SPDT Type

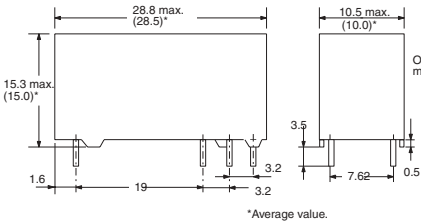
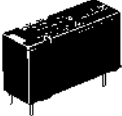

Terminal Arrangement/ Internal Connections (Bottom View)

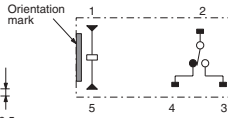

Mounting Holes (Bottom View)

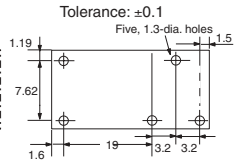

SPST-NO Type

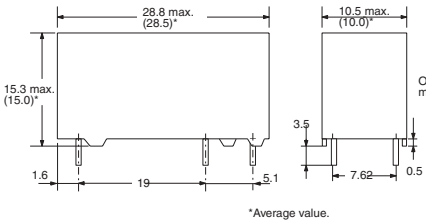
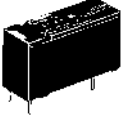

Terminal Arrangement/ Internal Connections (Bottom View)

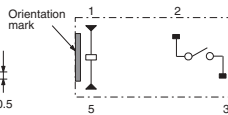

Mounting Holes (Bottom View)

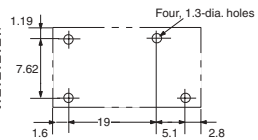

ALL DIMENSIONS SHOWN ARE IN MILLIMETERS.

To convert millimeters into inches, multiply by 0.03937. To convert grams into ounces, multiply by 0.03527.

A Cubic, Single-pole 10-A Power Relay

- ROHS compliant.
- Sub-miniature 'sugar cube' relay with universal terminal footprint.
- Conforms to EN 61810-1, UL508, CSA22.2.
- Tracking resistance: CTI>250 (-VD type).
- UL class-F coil insulation model available (UL class-B coil insulation for standard model).
- High switching power: 10 A.
- Two types of seal available; flux protection and fully sealed.
- Withstands impulse of up to 4,500 V.
- 400-mW and 360-mW coil power consumption types available.
- Pre-soldered terminals.



Ordering Information

Enclosure Rating	Contact Form	Contact Material	
		AgSnO ₂	AgSnIn
Flux protection	SPDT	G5LE-1 G5LE-1-VD G5LE-1-CF	G5LE-1-ASI G5LE-1-ASI-VD G5LE-1-ASI-CF
	SPST-NO	G5LE-1A G5LE-1A-VD G5LE-1A-CF	G5LE-1A-ASI G5LE-1A-ASI-VD G5LE-1A-ASI-CF
Fully sealed	SPDT	G5LE-14 G5LE-14-VD G5LE-14-CF	G5LE-14-ASI G5LE-14-ASI-VD G5LE-14-ASI-CF
	SPST-NO	G5LE-1A4 G5LE-1A4-VD G5LE-1A4-CF	G5LE-1A4-ASI G5LE-1A4-ASI-VD G5LE-1A4-ASI-CF

Note: When ordering, add the rated coil voltage to the model number.

Example: G5LE-1 12 VDC
└───┘ Rated coil voltage

Model Number Legend

G5LE - - - - VDC
1 2 3 4 5 6 7 8

1. Number of Poles

1: 1 pole

2. Contact Form

None: SPDT
 A: SPST-NO

3. Enclosure ratings

None: Flux protection
 4: Fully sealed

4. Contact Material

None: AgSnO₂
 ASI: AgSnIn

5. Insulation System

None: Class B
 CF: Class F (UL and CSA only)

6. Coil Power Consumption/Coil Characteristic

None: Approx. 400 mW
 36: Approx. 360 mW

7. Approved Standards

None: UL, CSA, TÜV
 VD: UL, CSA, TÜV and VDE
 (Not applicable with "-CF.")

8. Rated Coil Voltage

5, 9, 12, 24, 48 VDC

Specifications

■ Coil Ratings

400-mW Type

Rated voltage	5 VDC	9 VDC	12 VDC	24 VDC	48 VDC
Rated current	79.4 mA	45 mA	33.3 mA	16.7 mA	8.33 mA
Coil resistance	63 Ω	200 Ω	360 Ω	1,440 Ω	5,760 Ω
Must operate voltage	75% max. of rated voltage				
Must release voltage	10% min. of rated voltage				
Max. voltage	130% of rated voltage at 85°C, 170% of rated voltage at 23°C				
Power consumption	Approx. 400 mW				

Note: The rated current and coil resistance are measured at a coil temperature of 23°C with a tolerance of ±10%.

360-mW Type

Rated voltage	5 VDC	9 VDC	12 VDC	24 VDC	48 VDC
Rated current	72 mA	40 mA	30 mA	15 mA	7.5 mA
Coil resistance	70 Ω	225 Ω	400 Ω	1,600 Ω	6,400 Ω
Must operate voltage	75% max. of rated voltage				
Must release voltage	10% min. of rated voltage				
Max. voltage	130% of rated voltage (at 85°C), 170% of rated voltage (at 23°C)				
Power consumption	Approx. 360 mW				

Note: The rated current and coil resistance are measured at a coil temperature of 23°C with a tolerance of ±10%.

■ Contact Ratings

Load	Resistive load ($\cos\phi = 1$)
Rated Load	10 A at 120 VAC; 8 A at 30 VDC; 10 A at 250 VAC (12 + 24 VDC)
Rated Carry Current	10 A
Max. switching voltage	250 VAC, 125 VDC (30 VDC when UL/CSA standard is applied)
Max. switching current	AC: 10 A; DC: 8 A
Max. switching power	1,200 VA, 240 W
Failure rate (reference value)	100 mA at 5 VDC

■ Characteristics

Contact resistance	100 mΩ max.
Operate time	10 ms max.
Release time	5 ms max.
Bounce Time	Operate: Approx. 0.6 ms Release: Approx. 7.2 ms
Max. switching frequency	Mechanical: 18,000 operations/hr Electrical: 1,800 operations/hr at rated load
Insulation resistance	100 MΩ min. (at 500 VDC)
Dielectric strength	2,000 VAC, 50/60 Hz for 1 min between coil and contacts 750 VAC, 50/60 Hz for 1 min between contacts of same polarity
Impulse withstand voltage	4,500 V (1.2 50 μs) between coil and contacts
Vibration resistance	Destruction: 10 to 55 to 10 Hz, 0.75-mm single amplitude (1.5-mm double amplitude) Malfunction: 10 to 55 to 10 Hz, 0.75-mm single amplitude (1.5-mm double amplitude)
Shock resistance	Destruction: 1,000 m/s ² Malfunction: 100 m/s ²
Endurance	Mechanical: 10,000,000 operations min. (at 18,000 operations/hr) Electrical: 100,000 operations min. (at 1,800 operations/hr) 36,000 operations min. (10 A at 250 VAC)
Ambient temperature	Operating: -40°C to 85°C (with no icing)
Ambient humidity	Operating: 5% to 85%
Weight	Approx. 12 g

■ Approved Standards

UL508, UL114, UL478, UL325, UL873, UL1409, UL1950 (File No. E41643)/CSA C22.2 No. 14, No. 1 (File No. LR34815)

Model	Coil ratings	Contact ratings
G5LE	3 to 48 VDC	12 A, 120 VAC (resistive load 30,000 cycles) 10 A, 250 VAC (general use) 10 A, 125 VAC (general use 100,000 cycles) 8 A, 30 VDC (resistive load) 6 A, 277 VAC (general use) NO: 1/6 hp, 120 VAC (50,000 cycles) 1/3 hp, 125 VAC, 70°C 30K with Class 130B system 65°C 30K with Class 105 Coil insulation system TV-3, 120 VAC TV-5, 120 VAC (For ASI only) NC: 1/8 hp, 120 VAC (50,000 cycles) 1/10 hp, 120 VAC (50,000 cycles)

EN 61810-1, EN 60255, IEC (VDE TUV Reg No. R9151267, VDE Reg No. 6850UG)

Model	Coil ratings	Contact ratings
G5LE	<u>Approx. 400 mW</u> 3, 5, 6, 9, 12, 24, 48 VDC <u>Approx. 360 mW</u> 5, 6, 12, 24, 48 VDC	10A, 250 VAC (resistive load 50,000 cycles at 85°C) 5A, 30VDC 2.5A, 250VAC (cos = 0.4)

Engineering Data

**Maximum Switching Power
G5LE**

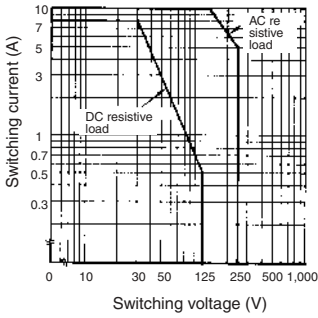

**Endurance
G5LE**

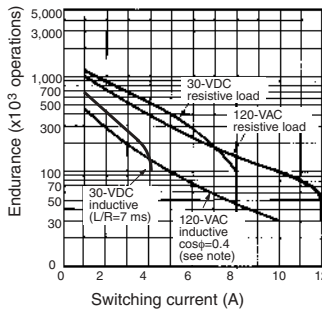

Note: Same curve as for 250-VAC resistive load

**Ambient Temperature vs.
Maximum Coil Voltage**

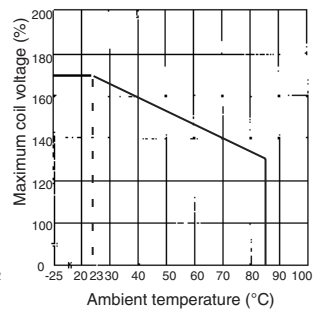

Note: The maximum coil voltage refers to the maximum value in a varying range of operating power voltage, not a continuous voltage.

Dimensions

Note: 1. All units are in millimeters unless otherwise indicated.
 2. Orientation marks are indicated as follows:

**G5LE-1
 G5LE-1A**

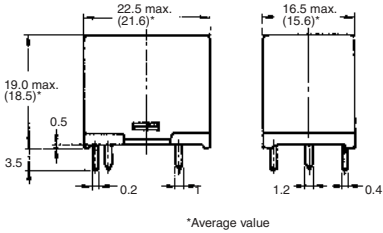
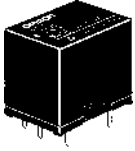

**G5LE-14
 G5LE-1A4**

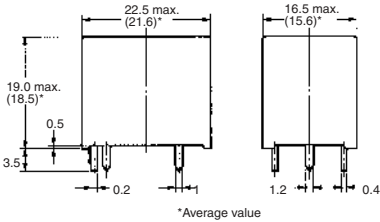
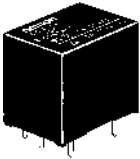

Terminal Arrangement/Internal Connections (Bottom View)

SPDT

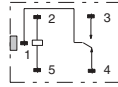

Mounting Holes (Bottom View)

Tolerance: 0.1 mm unless specified

SPDT

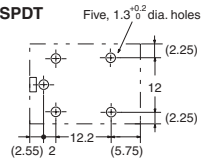

Terminal Arrangement/Internal Connections (Bottom View)

SPST-NO

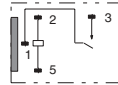

Mounting Holes (Bottom View)

Tolerance: 0.1 mm unless specified

SPST-NO

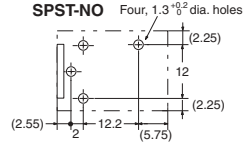

ALL DIMENSIONS SHOWN ARE IN MILLIMETERS.

To convert millimeters into inches, multiply by 0.03937. To convert grams into ounces, multiply by 0.03527.

A Cubic, Single-pole 10-A Power Relay

- ROHS compliant.
- L 19.6 x W 15.6 x H 15.2 (mm)
- Subminiature ‘Sugar Cube’ relays.
- Standard 360mW – Lower Coil power consumption.
- Standard Class B insulation, (Class F available).
- Standard CTI 175, (CTI 250 available).
- Withstands impulse of up to 4,500V.
- Approved to EN 61810-1

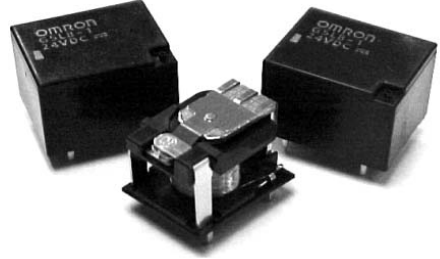

Ordering Information

Sealing	Contact Form	Contact Material
		AgSnO ₂
Unsealed (vent hole)	SPDT	G5LB-1
	SPST-NO	G5LB-1A
Plastic-sealed	SPDT	G5LB-14
	SPST-NO	G5LB-1A4

Note: When ordering, add the rated coil voltage to the number.

Examples : G5LB-1 12 VDC

Rated Coil Voltage

Model Number Legend

G5LB VDC
 1 2 3 4 5 6 7 8

- | | | |
|---|--|--|
| <p>1. Number of Poles
1: 1 pole</p> <p>2. Contact Form/Contact Construction
None: SPDT
A: SPST-NO</p> <p>3. Sealing/Protective Construction
None: Unsealed (vent hole)
4: Sealed</p> | <p>4. Contact Type
None: Standard (Silver Tin Oxide)</p> <p>5. Coil Power Consumption
None: 360mW
40: 400mW
60: 600mW (UL and CSA only)</p> <p>6. Tracking Index and Insulation
None: CTI >175 – Class B Insulation
25: CTI >250 – Class F Insulation</p> | <p>7. Optional Suffix(es)
None: Standards
May include additional numbers(s) and / or letter(s) for sales purposes</p> <p>8. Rated Coil Value</p> |
|---|--|--|

■ Coil Ratings

Rated voltage	3 VDC	5 VDC	6 VDC	9 VDC	12 VDC	24 VDC	36 VDC	48 VDC
Rated current	123.3 mA	72.0 mA	60.8 mA	40.8 mA	30.7 mA	15.2 mA	10.2 mA	7.6 mA
Coil resistance	24.3 Ω	69.4 Ω	98.7 Ω	220.4 Ω	390.6 Ω	1575.4 Ω	3533.7 Ω	6287.4 Ω
Must operate voltage	75% of rated voltage (max.)							
Must release voltage	10% of rated voltage (min.)							
Max. voltage	130% of rated voltage at 85°C, 170% of rated voltage at 23°C							
Power consumption	Approx. 360 mW							

Note: The rated current and coil resistance are measured at a coil temperature of 23°C with a tolerance of ±10%.

Rated voltage	3 VDC	5 VDC	6 VDC	9 VDC	12 VDC	24 VDC	36 VDC	48 VDC
Rated current	136.4 mA	80.0 mA	67.8 mA	45.7 mA	32.8 mA	17.0 mA	11.3 mA	8.5 mA
Coil resistance	22.0 Ω	62.5 Ω	88.5 Ω	196.9 Ω	366.0 Ω	1,407.7 Ω	3,196.8 Ω	5,638.0 Ω
Must operate voltage	75% of rated voltage (max.)							
Must release voltage	10% of rated voltage (min.)							
Max. voltage	130% of rated voltage at 85°C, 170% of rated voltage at 23°C							
Power consumption	Approx. 400 mW							

Note: The rated current and coil resistance are measured at a coil temperature of 23°C with a tolerance of ±10%.

Rated voltage	3 VDC	5 VDC	6 VDC	9 VDC	12 VDC	24 VDC	36 VDC	48 VDC
Rated current	200.2 mA	120.0 mA	100.7 mA	66.8 mA	50.4 mA	25.3 mA	16.6 mA	12.6 mA
Coil resistance	15.0 Ω	41.7 Ω	59.6 Ω	134.8 Ω	237.9 Ω	947.6 Ω	2164.8 Ω	3800.0 Ω
Must operate voltage	75% of rated voltage (max.)							
Must release voltage	10% of rated voltage (min.)							
Max. voltage	130% of rated voltage at 85°C, 170% of rated voltage at 23°C							
Power consumption	Approx. 600 mW							

Note: The rated current and coil resistance are measured at a coil temperature of 23°C with a tolerance of ±10%.

■ Contact Ratings

Load	Resistive load (cos φ=1)
Rated load	10A at 120 VAC, 8A at 30 VDC & 10A at 250 VAC
Rated carry current	10A
Max. switching voltage	250 VAC, 125 VDC (30 VDC when UL/CSA standard is applied)
Max. switching current	AC: 10A; DC: 8A
Max. switching capacity	1,200 VA, 240 W & 2,500 VA
Min. permissible load	100 mA at 5 VDC

■ Approved Standards

UL 325, UL 873 (File No. E41643)/CSA 22.2 No. 14 (File No. LR34815)
EN 61810-1 (VDE Reg. no A662)

Model	Coil Ratings	Contact Ratings
G5LB	3 - 48 VDC	10A 250 VAC 10A 30 VDC

■ Characteristics

Contact resistance	100 mΩ max.
Operate time	10 ms max.
Release time	5 ms max.
Max. switching frequency	Mechanical: 18,000 operations/hr Electrical: 1,800 operations/hr (under rated load)
Insulation resistance	100MΩ min. (at 500 VDC)
Dielectric strength	750 VAC, 50/60 Hz for 1 min. between contacts of same polarity 2,000 VAC, 50/60 Hz for 1 min. between coil and contacts
Impulse withstand voltage	4,500V between coil and contacts, 1.2 x 5 μsec
Vibration resistance	Destruction: 10 to 55Hz, 1.5mm double amplitude Malfunction: 10 to 55Hz, 1.5mm double amplitude
Shock resistance	Destruction: 1,000 m/s ² (approx. 100G) Malfunction: 100 m/s ² (approx. 10G)
Life expectancy	Mechanical: 10,000,000 operations min. (at 18,000 operations/hr) Electrical: *100,000 operations min. (at 1,800 operations/hr, 10A 120VAC)
Ambient temperature	Operating: -40°C to 85°C
Ambient humidity	Operating: 35% to 85°C
Weight	Approx. 10g*

*G5LB-1

Engineering Data

Max. Switching Capacity G5LB-1

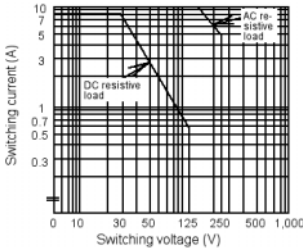

Life Expectancy G5LB-1

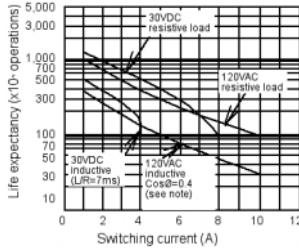

Note: Curve 120VAC inductive Cosφ=0.4 is same for 250VAC resistive load.

Ambient Temp. Vs Max. Voltage

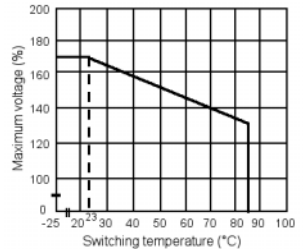

Note: The maximum coil voltage refers to the maximum value in a varying range of operating power voltage, not a continuous voltage.

Dimensions

Note: 1. All units are millimeters unless otherwise indicated

2. Orientation marks are indicated as follows:  

■ SPDT Types

G5LB-1

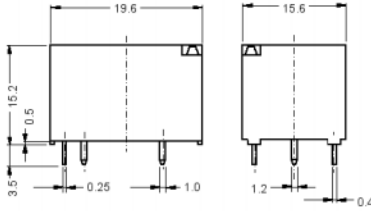

Terminal Arrangement/
Internal Connections
(Bottom View)

Mounting Holes
(Bottom View)
Tolerance: $\pm 0.1\text{mm}$

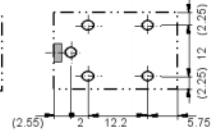
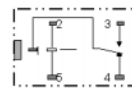

G5LB-14

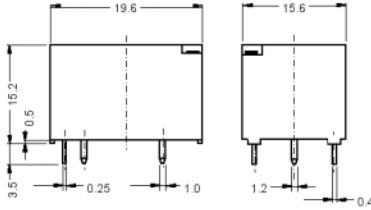

Terminal Arrangement/
Internal Connections
(Bottom View)

Mounting Holes
(Bottom View)
Tolerance: $\pm 0.1\text{mm}$

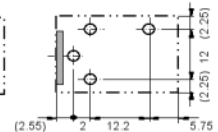
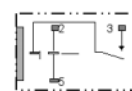

■ SPST Types

G5LB-1A

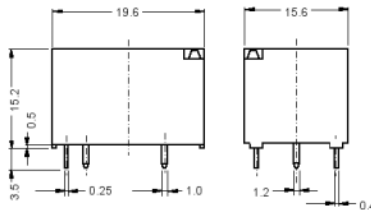

Terminal Arrangement/
Internal Connections
(Bottom View)

Mounting Holes
(Bottom View)
Tolerance: $\pm 0.1\text{mm}$

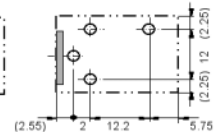
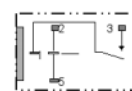

G5LB-1A4

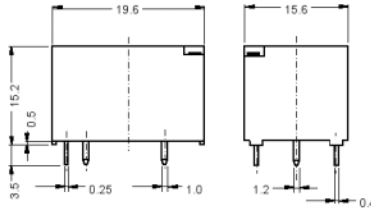

Terminal Arrangement/
Internal Connections
(Bottom View)

Mounting Holes
(Bottom View)
Tolerance: $\pm 0.1\text{mm}$

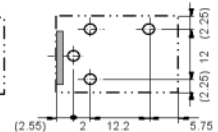
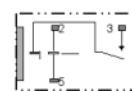

A Cubic, Single-pole 10-A Power Relay

- ROHS compliant.
- Subminiature ‘sugar cube’ relay with universal terminal footprint.
- Conforms to EN 61810-1, UL508, CSA22.2.
- High switching power: 10 A. 250 VAC
- Two types of seal available; flux protection and fully sealed.
- Withstands impulse of up to 4,500 V.
- Coil power consumption: 360 mW
- Tracking resistance: CTI >250



Ordering Information

Enclosure ratings	Contact form	Model
Flux protection	SPDT	G5LC-1-EU
	SPST-NO	G5LC-1A-EU
Fully sealed	SPDT	G5LC-14-EU
	SPST-NO	G5LC-1A4-EU

Note: When ordering, add the rated coil voltage to the model number.

Example: G5LC-1-EU 12 VDC
 Rated coil voltage

Model Number Legend

G5LC - - EU VDC
1 2 3 4

1. Number of Poles

1: 1 pole

2. Contact Form

None: SPDT
 A: SPST-NO

3. Enclosure Ratings

None: Flux protection
 4: Fully sealed

4. Rated Coil Voltage

5, 12, 24 VDC

■ Coil Ratings

Rated voltage	5 VDC	12 VDC	24 VDC
Rated current	71.5mA	30 mA	15.1 mA
Coil resistance	69.9 Ω	390 Ω	1.585 Ω
Must operate voltage	75% max. of rated voltage		
Must release voltage	10% min. of rated voltage		
Max. voltage	110% of rated voltage at 85°C		
Power consumption	Approx. 360 mW		

Note: The rated current and coil resistance are measured at a coil temperature of 23°C with a tolerance of ±10%.

■ Contact Ratings

Load	Resistive load ($\cos\phi = 1$)
Rated Load	10 A at 250 VAC (NO), 12 A at 120 VAC (NO), 5 A at 120 VAC (NO/NC) 10 A at 24 VDC (NO), 5 A at 24 VDC (NO/NC)
Rated Carry Current	12 A
Max. switching voltage	250 VAC, 125 VDC (30 VDC when UL/CSA standard is applied)
Max. switching current	AC: 12 A; DC: 12 A
Max. switching power	1,200 VA, 240 W
Failure rate (reference value)	100 mA at 5 VDC (P level: $\lambda_{60} = 0.1 \times 10^{-6}$ operation)

■ Characteristics

Contact resistance	100 m Ω max.
Operate time	10 ms max.
Release time	5 ms max.
Insulation resistance	1,000 M Ω min. (at 500 VDC)
Dielectric strength	2,000 VAC, 50/60 Hz for 1 min between coil and contacts 750 VAC, 50/60 Hz for 1 min between contacts of same polarity
Impulse withstand voltage	4,500 V (1.2 x 50 ms) between coil and contacts
Vibration resistance	Destruction: 10 to 55 to 10 Hz, 0.75-mm single amplitude (1.5-mm double amplitude) Malfunction: 10 to 55 to 10 Hz, 0.75-mm single amplitude (1.5-mm double amplitude)
Shock resistance	Destruction: 1,000 m/s ² Malfunction: 100 m/s ²
Endurance	Mechanical: 10,000,000 operations min. (at 36,000 operations/hr) Electrical: 100,000 operations min. (at 1,800 operations/hr)
Ambient temperature	Operating: -25°C to 85°C (with no icing)
Ambient humidity	Operating: 5% to 85%
Weight	Approx. 12 g

■ Approved Standards

UL508, UL873 (File No. E41643)/CSA C22.2 No. 14, No. 0 (File No. LR31928)

Model	Coil ratings	Contact ratings
G5LC-EU	5 to 24 VDC	NO: 10 A, 250 VAC (general use) 10 A, 24 VDC (resistive load) 1/8 hp, 120 VAC (50,000 cycles) 12 A, 120 VAC (resistive load) NC: 1/8 hp, 120 VAC (50,000 cycles)

EN 61810-1 (VDE Reg. no 40002435)

Model	Coil ratings	Contact ratings
G5LC-EU	Approx. 360 mW 5, 12, 24 VDC	5 A, 250 VAC (NC) 10 A, 250 VAC (NO)

Engineering Data

**Maximum Switching Power
G5LC**

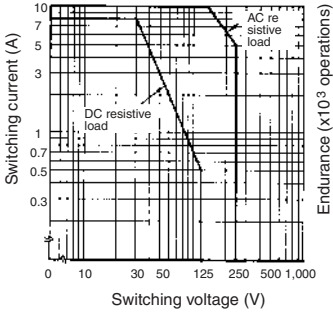

**Endurance
G5LC**

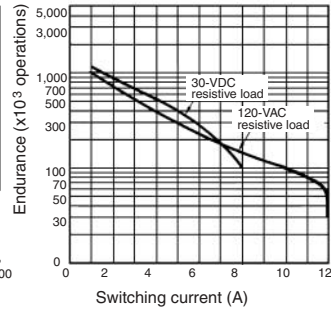

Note: Same curve as for 250-VAC resistive load

**Ambient Temperature vs.
Maximum Coil Voltage**

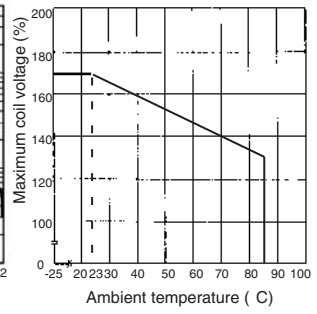

Note: The maximum coil voltage refers to the maximum value in a varying range of operating power voltage, not a continuous voltage.

Dimensions

Note: 1. All units are in millimeters unless otherwise indicated.

2. Orientation marks are indicated as follows:

G5LC-EU

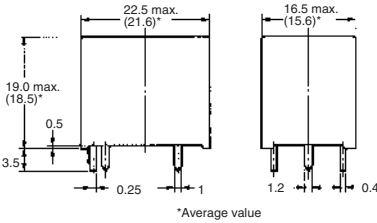

Terminal Arrangement/Internal Connections (Bottom View)

SPDT

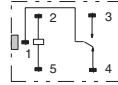

Mounting Holes (Bottom View)

Tolerance: 0.1 mm unless specified

SPDT

Five, 1.3^{+0.2} dia. holes

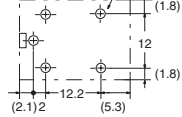

Terminal Arrangement/Internal Connections (Bottom View)

SPST-NO

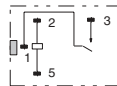

Mounting Holes (Bottom View)

Tolerance: 0.1 mm unless specified

SPST-NO

Four, 1.3^{+0.2} dia. holes

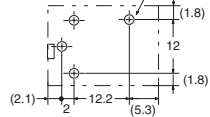

Precautions

Basic Information

Before actually committing any component to a mass-production situation, OMRON strongly recommends situational testing, in as close to actual production situations as possible. One reason is to confirm that the product will still perform as expected after surviving the many handling and mounting processes involved in mass production. Also, even though OMRON relays are individually tested a number of times, and each meets strict requirements, a certain testing tolerance is permissible. When a high-precision product uses many components, each depends upon the rated performance thresholds of the other components. Thus, the overall performance tolerance may accumulate into undesirable levels. To avoid problems, always conduct tests under the actual application conditions.

General

To maintain the initial characteristics of a relay, exercise care that it is not dropped or mishandled. For the same reason, do not remove the case of the relay; otherwise, the characteristics may degrade. Avoid using the relay in an atmosphere containing sulfuric acid (SO₂), hydrogen sulfide (H₂S), or other corrosive gases. Do not continuously apply a voltage higher than the rated maximum voltage to the relay. Never try to operate the relay at a voltage and a current other than those rated.

Do not use the relay at temperatures higher than that specified in the catalog or data sheet.

ALL DIMENSIONS SHOWN ARE IN MILLIMETERS.

To convert millimeters into inches, multiply by 0.03937. To convert grams into ounces, multiply by 0.03527.

Flat Relays that Switch 10-A/15-A Loads with New Quick-connect Terminals

- ROHS compliant.
- Ideal for switching power in household appliances or for outputs from industrial devices.
- Sub-miniature dimensions: 22 x 16 x 11 mm (L x W x H).
- High-sensitivity models available with low power consumption (150 mW).
- UL and CSA approved.
- Fully sealed models and quick-connect terminal models available (#187 load contact



Ordering Information

Contact form	Enclosure ratings	General purpose	High-sensitivity	High-capacity	Quick-connect terminals
SPST-NO	Flux protection	G5CA-1A	G5CA-1AH	G5CA-1AE	G5CA-1AE-TP-E
-	Fully sealed	G5CA-1A4	G5CA-1A4H	-	-

- Note:** 1. When ordering, add the rated coil voltage to the model number.
 Example: G5C-1 12 VDC
Rated coil voltage
2. High-capacity models with a Fully sealed structure are not available.
3. Standard or high-sensitivity models with quick-connect terminals are not available.

Model Number Legend

G5CA-1A – – – – – VDC

1 2 3 4 5 6

1. Number of Poles
 1A: 1 pole (SPST-NO)

4. Special functions
 None: Standard
 E: High capacity

Standard Specifications
 Contact configuration: SPST-NO
 Enclosure ratings: Flux protection
 Terminal form: PCB terminal

2. Enclosure Ratings
 None: Flux protection
 4: Fully sealed

5. Coil Consumption
 None: Standard
 H: High sensitivity

3. Terminal Form
 None: PCB Terminal
 TP: Quick-connect terminal (#187)

6. Rated coil voltage
 5, 12, 24 VDC

■ Coil Ratings

Item	Standard, high-capacity, or quick-connect terminals			High-sensitivity		
	5 VDC	12 VDC	24 VDC	5 VDC	12 VDC	24 VDC
Rated current	40 mA	16.7 mA	8.3 mA	30 mA	12.5 mA	6.25 mA
Coil resistance	125 Ω	720 Ω	2,880 Ω	167 Ω	960 Ω	3,840 Ω
Must operate voltage	75% max. of rated voltage			80% max. of rated voltage		
Must release voltage	10% min. of rated voltage					
Max. voltage	150% (standard)/130% (high-capacity, quick-connect terminals) of rated voltage (at 23°C)			150% (at 23°C)		
Power consumption	Approx. 200 mW			Approx. 150 mW		

■ Contact Ratings

Item	Standard		High-sensitivity		High-capacity, or quick-connect terminals	
	Resistive load ($\cos\phi = 1$)	Inductive load ($\cos\phi = 0.4$, L/R = 7 ms)	Resistive load ($\cos\phi = 1$)	Inductive load ($\cos\phi = 0.4$, L/R = 7 ms)	Resistive load ($\cos\phi = 1$)	Inductive load ($\cos\phi = 0.4$, L/R = 7 ms)
Contact Material	Silver Alloy (cadmium free)		Silver Alloy (cadmium free)		Silver Alloy (cadmium free)	
Rated load	10 A at 250 VAC; 10 A at 30 VDC	3 A at 250 VAC; 3 A at 30 VDC	10 A at 250 VAC; 10 A at 30 VDC	3 A at 250 VAC; 3 A at 30 VDC	15 A at 110 VAC; 10 A at 30 VDC	5 A at 110 VAC; 3 A at 30 VDC
Rated carry current	10 A		10 A		15 A	
Max. switching voltage	250 VAC, 125 VDC		250 VAC, 125 VDC		250 VAC, 125 VDC	
Max. switching current	10 A		10 A		15 A	
Max. switching	2,500 VA, 300 W	750 VA, 90 W	2,500 VA, 300 W	750 VA, 90 W	2,500 VA, 300 W	750 VA, 90 W

■ Characteristics

Contact resistance	30 mΩ max. (Quick-connect terminals type: 100 mΩ max.)
Operate time	10 ms max. (High-sensitivity type: 15 ms max.)
Release time	10 ms max.
Insulation resistance	1,000 MΩ min.
Dielectric strength	2,500 VAC, 50/60 Hz for 1 min between contacts of same polarity 1,000 VAC, 50/60 Hz for 1 min between contacts of same polarity
Impulse withstand voltage	4,500 V (1.2 x 50 μs) between coil and contacts
Vibration resistance	Destruction: 10 to 55 to 10 Hz, 0.75-mm single amplitude (1.5-mm double amplitude) Malfunction: 10 to 55 to 10 Hz, 0.75-mm single amplitude (1.5-mm double amplitude)
Shock resistance	Destruction: 1,000 m/s ² Malfunction: 200 m/s ²
Endurance	Mechanical: 20,000,000 operations min. at 18,000 operations/hr Electrical: 300,000 operations min. (100,000 operations min. for Fully sealed Type) at 1,200 operations/hr under rated load of 10 A at 250 VAC; 100,000 operations min. under load of 15 A at 110 VAC for high-capacity models 100,000 operations min. at 1,200 operations/hr under rated load of 10 A at 30 VDC
Ambient temperature	Operating: -25°C to 70°C (with no icing)
Ambient humidity	Operating: 5% to 85%
Weight	Approx. 8 g (for TP model: Approx. 9.6 g)

Note: 1. The rated current and coil resistance are measured at a coil temperature of 23°C with a tolerance of ±10%.
2. Operating characteristics are measured at a coil temperature of 23°C.

■ Approved Standards

UL508 (File No. E41515)/CSA C22.2 No.14 (File No. LR31928)

IEC/VDE standard/TUV Certified: IEC255/VDE0435 (Certification No.R9351138)

Model	Coil ratings
3 to 100 VDC	15 A, 125 VAC 10 A, 250 VAC 10 A, 30 VDC (resistive load only)

■ Engineering Data

Maximum Switching Power

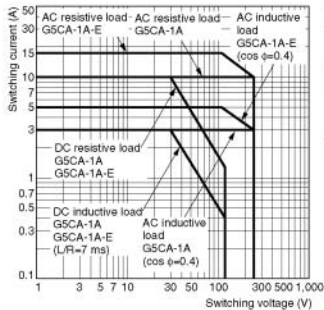

Endurance

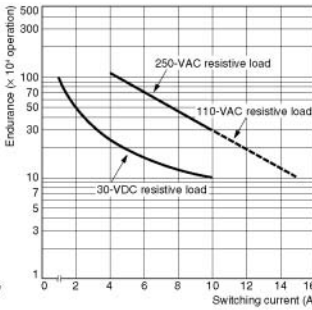

Ambient Temperature vs. Maximum Coil Voltage

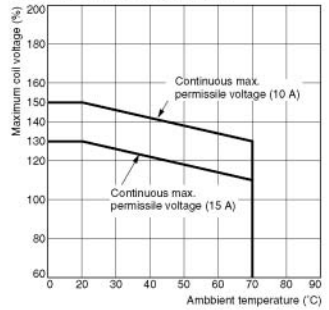

Operating Temperature vs. Must-operate/Must-release Voltage

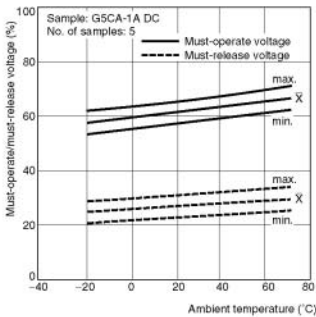

Malfunction Shock

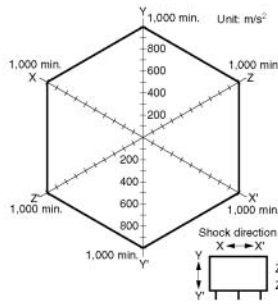

No. of samples: 10
Measured value: The value at which malfunction occurs in the contact when the contact is subjected to shock three times each in six directions for three axes.
Standard: 200 m/s²

Note: The 'maximum voltage' is the maximum voltage that can be applied to the relay coil.

Dimensions

Note: 1. All units are in millimeters unless otherwise indicated.

2. Orientation marks are indicated as follows:



G5CA-1A(E)
G5CA-1A4(-H)

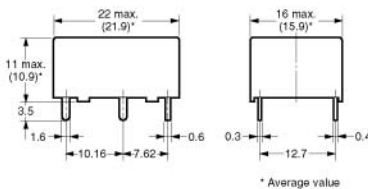

Mounting Holes (PCB)
(BOTTOM VIEW)
Tolerance: ±0.1 mm

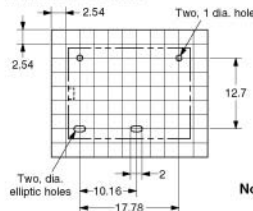

Terminal Arrangement/
Internal Connections
(BOTTOM VIEW)

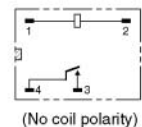

Note: Orientation marks are indicated as follows: □ □

Dimensions (cont)

G5CA-1A-TP-E

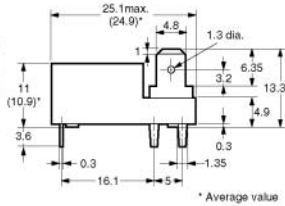
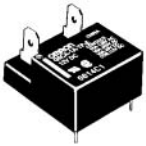

Mounting Holes
(BOTTOM VIEW)
Tolerance: ±0.1 mm

Terminal Arrangement/
Internal Connections
(BOTTOM VIEW)

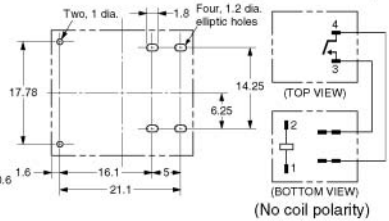

Precautions

■ Precautions for Correct Use

Installation

Make sure that sufficient space is provided between relays when installing two or more relays side by side to facilitate heat dissipation. Insufficient heat dissipation may result in the relay malfunctioning.

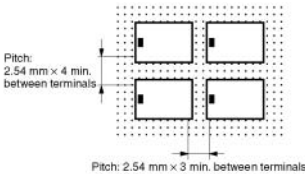

Charged Terminals

The section marked with dotted circles (indicated by arrows) in the following diagram includes the charged terminals of the relay. When the relay is mounted on a PCB, make sure that there are no metal patterns on the section of the PCB facing the portion of the relay shaded in the following diagram.

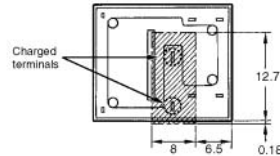

Quick-connect Terminal Connections

- Do not pass current through the PCB of the load contact terminals (quick-connect terminals).
- The terminals are compatible with Faston receptacle #187 and are suitable for positive-lock mounting.

Use only Faston terminals with the specified numbers. Select leads for connecting Faston receptacles with wire diameters that are within the allowable range for the load current. Do not apply excessive force to the terminals when mounting or dismounting the Faston receptacle.

Insert and remove terminals carefully one at a time. Do not insert terminals on an angle, or insert/remove multiple terminals at the same time.

The following positive-lock connectors made by AMP are recommended. Contact the manufacturer directly for details on connectors including availability.

Other Precautions

- The G5CA is a power relay designed for applications switching power loads such as heaters in electric household appliances. Do not use the G5CA to switch micro loads less than 100 mA, such as in signal applications.
- Use fully sealed models if the relays will require washing. Fluxprotection models may malfunction or the relay's performance may be otherwise adversely affected if cleaning fluid enters the relay.

Type	Type Receptacle terminals (See note.)	Positive housing
#187 terminals (width: 4.75 mm)	AMP 170330-1 (170324-1) AMP 170331-1 (170325-1) AMP 170332-1 (170326-1)	AMP 172074-1 (natural color) AMP 172074-4 (yellow) AMP 172074-5 (green) AMP 172074-6 (blue)

Note: The numbers shown in parentheses are for air-feeding

ALL DIMENSIONS SHOWN ARE IN MILLIMETERS.

To convert millimeters into inches, multiply by 0.03937. To convert grams into ounces, multiply by 0.03527.

SPST-NO Type Breaks 10-A Loads; SPST-NO + SPST-NC Type Breaks 8-A Load

- Compact: 20 x 15 x 10 mm (L x W x H).
- Low power consumption: 200 mW.
- Flux protection or fully sealed construction available.
- Unique moving loop armature reduces relay size, magnetic interference, and contact bounce.
- Single- and double-winding latching types also available

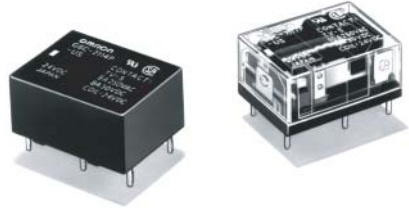

Ordering Information

Classification	Contact form	Straight PCB		Self-clinching PCB	
		Flux protection	Fully sealed	Flux protection	Fully sealed
Single-side stable	SPST-NO	G6C-1117P-US	G6C-1114P-US	G6C-1117C-US	G6C-1114C-US
	SPST-NO + SPST-NC	G6C-2117P-US	G6C-2114P-US	G6C-2117C-US	G6C-2114C-US
Single-winding latching	SPST-NO	G6CU-1117P-US	G6CU-1114P-US	G6CU-1117C-US	G6CU-1114C-US
	SPST-NO + SPST-NC	G6CU-2117P-US	G6CU-2114P-US	G6CU-2117C-US	G6CU-2114C-US
Double-winding latching	SPST-NO	G6CK-1117P-US	G6CK-1114P-US	G6CK-1117C-US	G6CK-1114C-US
	SPST-NO + SPST-NC	G6CK-2117P-US	G6CK-2114P-US	G6CK-2117C-US	G6CK-2114C-US

Note: When ordering, add the rated coil voltage to the model number.

Example: G6C-1117P-US 12 VDC

Rated coil voltage

Model Number Legend

G6C - VDC
1 2 3 4 5 6 7

1. Relay Function

- None: Single-side stable
- U: Single-winding latching
- K: Double-winding latching

2. Contact Form

- 11: SPST-NO
- 21: SPST-NO + SPST-NC

3. Contact Type

- 1: Standard

4. Enclosure Ratings

- 7: Flux protection
- 4: Fully sealed

5. Terminals

- P: Straight PCB
- C: Self-clinching PCB

6. Approved Standards

- US: UL/CSA certified

7. Rated Coil Voltage

- 3, 5, 6, 12, 24 VDC

■ Accessories (Order Separately)

Back Connecting Sockets

Applicable relay	Back connecting socket*
G6C(U)-1114P-US G6C(U)-1117P-US G6C(U)-2114P-US G6C(U)-2117P-US	P6C-06P
G6CK-1114P-US G6CK-1117P-US G6CK-2114P-US G6CK-2117P-US	P6C-08P

*Not applicable to the self-clinching type.

The operating current for the socket is 5 A max

Removal Tool	P6B-Y1
Hold-down Clips	P6B-C2

Specifications

■ Coil Rating

Single-side Stable Type

Rated voltage	3 VDC	5 VDC	6 VDC	12 VDC	24 VDC	
Rated current	67 mA	40 mA	33.3 mA	16.7 mA	8.3 mA	
Coil resistance	45 Ω	125 Ω	180 Ω	720 Ω	2,880 Ω	
Coil inductance	Armature OFF	0.078	0.22	0.36	1.32	4.96
(H) (ref. value)	Armature OFF	0.067	0.18	0.29	1.13	4.19
Must operate voltage	70% max. of rated voltage					
Must release voltage	70% min. of rated voltage					
Max. voltage	160% of rated voltage (at 23°C)					
Power consumption	Approx. 200 mW					

Single-side Latching Type

Rated voltage	3 VDC	5 VDC	6 VDC	12 VDC	24 VDC	
Rated current	67 mA	40 mA	33.3 mA	16.7 mA	8.3 mA	
Coil resistance	45 Ω	125 Ω	180 Ω	720 Ω	2,880 Ω	
Coil inductance	Armature OFF	0.09	0.25	0.36	1.75	5.83
(H) (ref. value)	Armature OFF	0.06	0.20	0.24	1.17	3.84
Must operate voltage	70% max. of rated voltage					
Must release voltage	70% min. of rated voltage					
Max. voltage	160% of rated voltage (at 23°C)					
Power consumption	Approx. 200 mW					

Double-winding Latching Type

Rated voltage		3 VDC	5 VDC	6 VDC	12 VDC	24 VDC	
Set coil	Rated current	93.5 mA	56.0 mA	46.7 mA	23.3 mA	11.7 mA	
	Coil resistance	32.1 Ω	89.3 Ω	129 Ω	514 Ω	2,056 Ω	
	Coil inductance	Armature OFF	0.03	0.07	0.10	0.37	1.56
	(H) (ref. value)	Armature OFF	0.02	0.06	0.08	0.32	1.18
Reset coil	Rated current	93.5 mA	56.0 mA	46.7 mA	23.3 mA	11.7 mA	
	Coil resistance	32.1 Ω	89.3 Ω	129 Ω	514 Ω	2,056 Ω	
	Coil inductance	Armature OFF	0.03	0.08	0.12	0.47	1.46
	(H) (ref. value)	Armature OFF	0.02	0.07	0.10	0.38	1.13
Must set voltage		70% max. of rated voltage					
Must reset voltage		70% min. of rated voltage					
Max. voltage		130% of rated voltage (at 23°C)					
Power consumption		Set coil: Approx. 280 mW Reset coil: Approx. 280 mW					

Note: 1. The rated current and coil resistance are measured at a coil temperature of 23°C with a tolerance of ±10%.

2. Operating characteristics are measured at a coil temperature of 23°C.

3. The minimum pulse width of the set and reset voltage is 20 ms.

■ Contact Ratings

Item	SPST-NO		SPST-NO+SPST-NC	
	Resistive load ($\cos\phi = 1$)	Inductive load ($\cos\phi = 0.4$; L/R = 7 ms)	Resistive load ($\cos\phi = 1$)	Inductive load ($\cos\phi = 0.4$; L/R = 7 ms)
Rated load	10 A at 250 VAC; 10 A at 30 VDC	5 A at 30 VAC; 5 A at 30 VDC	8 A at 30 VAC; 8 A at 30 VDC;	3.5 A at 250 VAC; 3.5 A at 30 VDC
Contact material	AgCdO (Cd free planned 1 Apr 05)			
Rated carry current	10 A		8 A	
Max. switching voltage	380 VAC, 125 VDC (the case of latching 250 VAC, 125 VDC)			
Max. switching current	10 A		8 A	
Max. switching power	2,500 VA, 300 W	1,250 VA, 220 W	2,000 VA, 240 W	875 VA, 170 W
Failure rate (reference value)	10 mA at 5 VDC			

■ Characteristics

Contact resistance	30 mΩ max.
Operate (set) time	10 ms max. (mean value: approx. 5 ms)
Release (reset) time	10 ms max. (mean value: approx. 2 ms; latching types: mean value: approx. 5 ms)
Bounce Time	Operate: 5 ms max. Release: 5 ms max.
Min. set/reset signal width	Latching type: 20 ms (at 23°C)
Max. switching frequency	Mechanical: 18,000 operations/hr Electrical: 1,800 operations/hr (under rated load)
Insulation resistance	1,000 MΩ min. (at 500 VDC, at 250 VDC between set coil and reset coil)
Dielectric strength	2,000 VAC, 50/60 Hz for 1 min between coil and contacts 2,000 VAC, 50/60 Hz for 1 min between contacts of different polarity 1,000 VAC, 50/60 Hz for 1 min between contacts of same polarity 250 VAC, 50/60 Hz for 1 min between set and reset coils
Impulse withstand voltage	6,000 V (1.2 x 50 μs) between coil and contacts (latching types: 4,500 V, 1.2 50 μs)
Vibration resistance	Destruction: 10 to 55 to 10 Hz, 0.75-mm single amplitude (1.5-mm double amplitude) Malfunction: 10 to 55 to 10 Hz, 0.75-mm single amplitude (1.5-mm double amplitude)
Shock resistance	Destruction: 1,000 m/s ² Malfunction: 100 m/s ²
Ambient temperature	Operating: -25°C to 70°C (with no icing)
Ambient humidity	Operating: 5% to 85%
Endurance	Mechanical: 50,000,000 operations min. (at 18,000 operations/hr) Electrical: 100,000 operations min. (at 1,800 operations/hr)
Weight	Approx. 5.6 g

■ Approved Standards UL508 (File No. E41643)

Model	Contact form	Coil rating	Contact rating
G6C-1114P-US G6C-1114C-US G6C-1117P-US G6C-1117C-US	SPST-NO	3 to 60 VDC	10 A, 250 VAC (general use) 10 A, 30 VDC (resistive load) 1/6 hp, 125 VAC 1/4 hp, 125 VAC 1/4 hp, 250 VAC 1/3 hp, 250 VAC TV-5 600 W, 120 VAC (tungsten) 530 VA, 20 to 265 VAC, 2 A max. (pilot duty) 43.2 VA, 30 VDC (pilot duty) 12LRA, 2.2FLA, 30 VDC (30,000 cycle)
G6C-2114P-US G6C-2114C-US G6C-2117P-US G6C-2117C-US	SPST-NO + SPST-NC		8 A, 250 VAC (general use) 8 A, 30 VDC (resistive load) 1/6 hp, 125 VAC 1/4 hp, 125 VAC 1/4 hp, 250 VAC TV-5 600 W, 120 VAC (tungsten)

■ Approved Standards (continued)
 CSA C22.2 No.14 (File No. LR31928)
 EN 61810-1 (VDE Reg. no 2413)

Model	Contact form	Coil rating	Contact rating
G6C-1114P-US G6C-1114C-US G6C-1117P-US G6C-1117C-US	SPST-NO	3 to 60 VDC	10 A, 250 VAC (general use) 10 A, 30 VDC (resistive load) 1/6 hp, 125 VAC 1/4 hp, 125 VAC 1/4 hp, 250 VAC 1/3 hp, 250 VAC TV-5 600 W, 120 VAC (tungsten)
G6C-2114P-US G6C-2114C-US G6C-2117P-US G6C-2117C-US	SPST-NO + SPST-NC	3 to 60 VDC	8 A, 250 VAC (general use) 8 A, 30 VDC (resistive load) 1/6 hp, 125 VAC 1/4 hp, 125 VAC 1/4 hp, 250 VAC TV-5 600 W, 120 VAC (tungsten)

■ Engineering Data

Maximum Switching Power
 SPST-NO

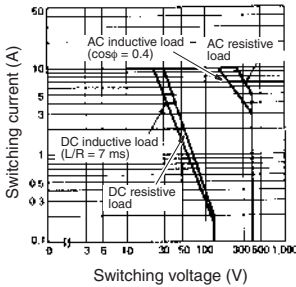

SPST-NO + SPST-NC

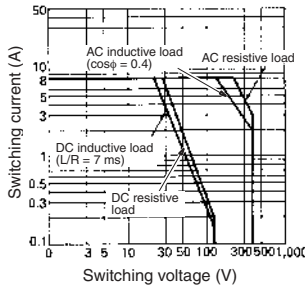

Endurance

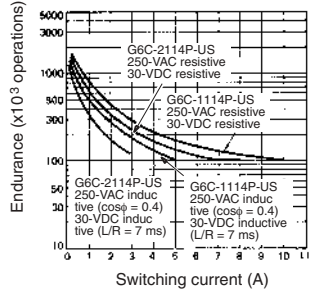

Ambient Temperature vs.
 Maximum Coil Voltage

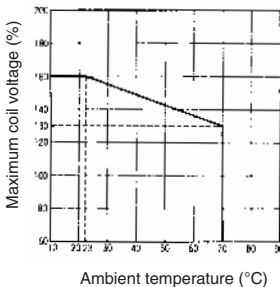

Note: The maximum coil voltage refers to the maximum value in a varying range of operating power voltage, not a continuous voltage.

Dimensions

Note: 1. All units are in millimeters unless otherwise indicated.
 2. Orientation marks are indicated as follows:

G6C-□117P-US

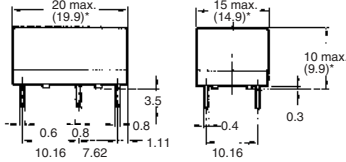
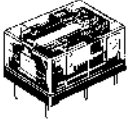

*Average value

**G6C-1177P-US, G6C-1117C-US
 G6C-1114P-US, G6C-1114C-US**
Terminal Arrangement/Internal Connections (Bottom View)

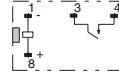

G6C-□117C-US

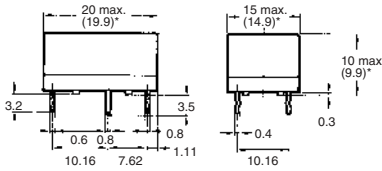
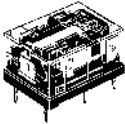

*Average value

Mounting Holes (Bottom View)
 Tolerance: 0.1

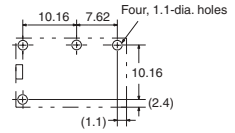

G6C-□114P-US

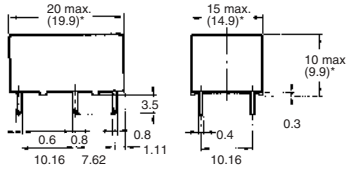
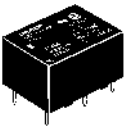

*Average value

**G6C-2117P-US, G6C-2117C-US
 G6C-2114P-US, G6C-2114C-US**
Terminal Arrangement/Internal Connections (Bottom View)

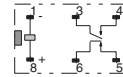

G6C-□114C-US

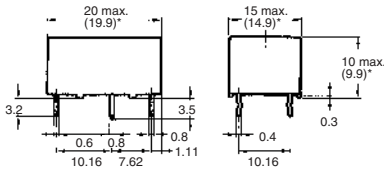
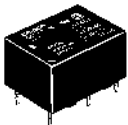

*Average value

Mounting Holes (Bottom View)
 Tolerance: 0.1

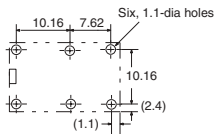

G6C-□117P-US

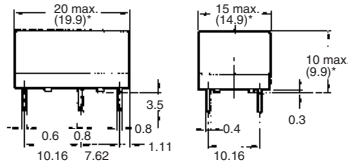
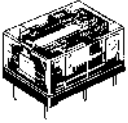

*Average value

G6C-117P-US, G6C-117C-US
G6C-114P-US, G6C-114C-US
Terminal Arrangement/Internal
Connections (Bottom View)

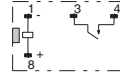

G6C-□117C-US

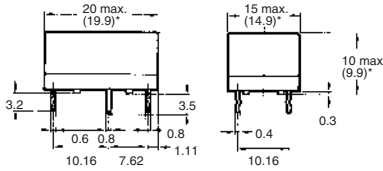
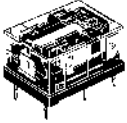

*Average value

Mounting Holes
(Bottom View)

Tolerance: 0.1

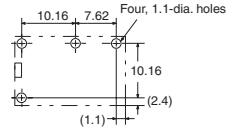

G6C-□114P-US

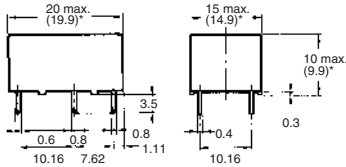
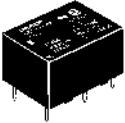

*Average value

G6C-2117P-US, G6C-2117C-US
G6C-2114P-US, G6C-2114C-US
Terminal Arrangement/Internal
Connections (Bottom View)

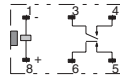

Mounting Holes
(Bottom View)

Tolerance: 0.1

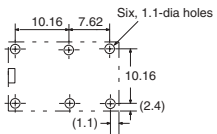

G6C-□114C-US

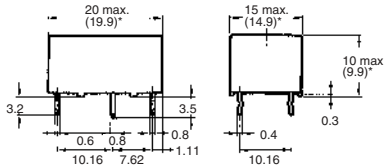
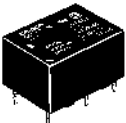

*Average value

G6CK-□117P-US

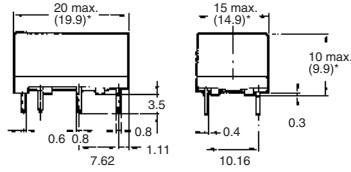

*Average value

G6CK-1117P-US, G6CK-1117C-US
G6CK-1114P-US, G6CK-1114C-US
Terminal Arrangement/Internal
Connections (Bottom View)

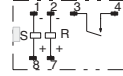

Mounting Holes
(Bottom View)

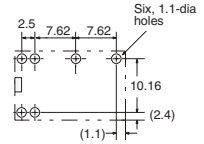

G6CK-□117C-US

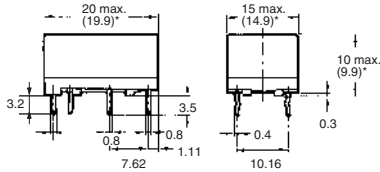
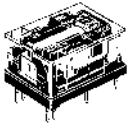

*Average value

G6CK-2117P-US, G6CK-2117C-US
G6CK-2114P-US, G6CK-2114C-US
Terminal Arrangement/Internal
Connections (Bottom View)

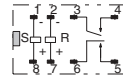

Mounting Holes
(Bottom View)

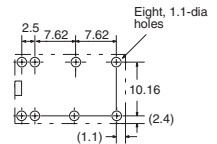

G6CK-□114P-US

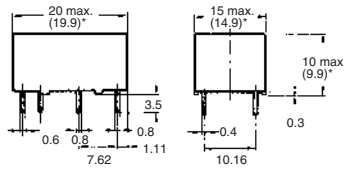
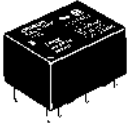

*Average value

G6CK-□114C-US

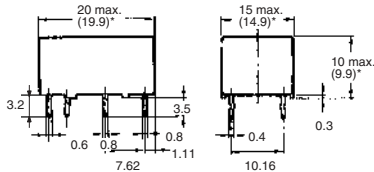
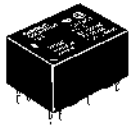

*Average value

Back Connecting Sockets
P6C-06P

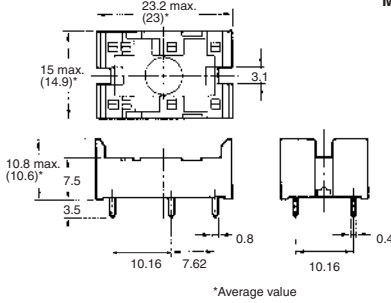

Mounting Holes (Bottom View)

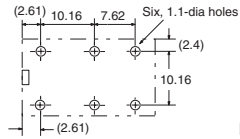

Mounting Height of Relay with Connecting Socket

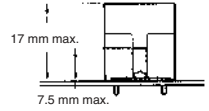

P6C-08P

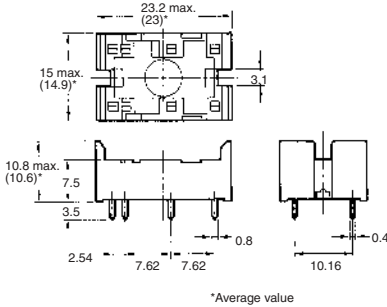

Mounting Holes (Bottom View)

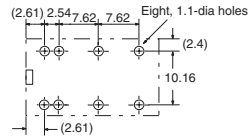

Note: Rated current of socket max. 5 A

Removal Tool
P6B-Y1

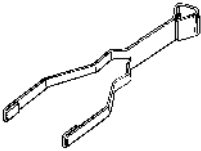

Hold-down Clips
P6B-C2



A Power Relay for a Variety of Purposes with Various Models

- Conforms to EN 61810-1, UL508, CSA22.2, SEV, SEMKO.
- Meets VDE0700 requirements for household products according to VDE0110.
- Clearance and creepage distance: 8 mm/8 m.
- Models with CTI250 material available.
- High-sensitivity (360 mW) and high-capacity (16 A) types available.
- Double-winding latching type available.
- Plug-in with test button and quick-connect terminals available.
- Highly functional socket available.



Ordering Information

Classification		Enclosure Ratings	Coil Ratings	Contact Form			
				SPST-NO	SPDT	DPST-NO	DPDT
PCB terminal	General-purpose	Flux protection	AC/DC	G2R-1A	G2R-1	G2R-2A	G2R-2
		Fully sealed		G2R-1A4	G2R-14	G2R-2A4	G2R-24
	Bifurcated contact	Flux protection	DC	G2R-1AZ	G2R-1Z	–	–
		Fully sealed		G2R-1AZ4	G2R-1Z4	–	–
	High-capacity	Flux protection	AC/DC	G2R-1A-E	G2R-1-E	–	–
	High-sensitivity	Flux protection	DC	G2R-1A-H	G2R-1-H	G2R-2A-H	G2R-2-H
Double-winding latching	Flux protection	G2RK-1A		G2RK-1	G2RK-2A	G2RK-2	
Plug-in terminal	General-purpose	Unsealed	AC/DC	–	G2R-1-S	–	G2R-2-S
				–	G2R-1-SN	–	G2R-2-SN
				–	G2R-1-SNI	–	G2R-2-SNI
	Diode		DC	–	G2R-1-SD	–	G2R-2-SD
				–	G2R-1-SND	–	G2R-2-SND
				–	G2R-1-SNDI	–	G2R-2-SNDI
Plug-in terminal (Bifurcated crossbar contact)	General-purpose	AC/DC	G2R-1A3-S	G2R-13-S	–	–	
			G2R-1A3-SN	G2R-13-SN	–	–	
			G2R-1A3-SND	G2R-13-SND	–	–	

Note: 1. When ordering, add the rated coil voltage to the model number.

Example: G2R-1A 12 VDC

Rated coil voltage

2. OMRON has also prepared the above relays with AgSnIn contacts, which are more tolerant of large inrush currents and physical movement compared with relays with standard contacts. When ordering, add "-ASI" to the model number.
Example: G2R-1A-ASI
3. Standard, NO contact type relays are TV-3 class products in accordance with the TV standards of the UL/CSA. Models with AgSnIn contacts are TV-5 class products.
Example: G2R-1A-ASI
When ordering a TV-8 class model, insert "-TV8" into the model number as follows:
Example: G2R-1A-TV8-ASI
4. Models with CTI250 material are also available.
Contact your OMRON representative for more details.

Model Number Legend

G2R □ - □ □ □ □ - □ □ □ □ - □ □ □ VDC
 1 2 3 4 5 6 7 8 9 10

1. Relay Function

None: Single-side stable
 K: Double-winding latching

2. Number of Poles

1: 1 pole
 2: 2 poles

3. Contact Form

None: PDT
 A: PST-NO

4. Contact Type

None: Single
 Z: Bifurcated
 3: Bifurcated crossbar

5. Enclosure Ratings

None: Flux protection
 4: Fully sealed

6. Terminals

None: Straight PCB
 S: Plug-in
 T: Quick-connect (upper bracket mounting)

7. Classification

None: General-purpose
 E: High-capacity
 H: High-sensitivity
 N: LED indicator
 D: Diode
 ND: LED indicator and diode

8. Test button

I: Test button
 Note: Applied for only SN and SND type

9. Contact Material

None: AgCdO (Cd free planned 1 Apr 05)
 ASI: AgSnIn

10. Rated Coil Voltage

Refer to Coil Ratings

■ Accessories (Order Separately)

Connecting Sockets

Number of Poles	Applicable Relay Model	Track/surface-mounting Socket	Back-mounting Socket	
			Terminals	Model
1 pole	G2R-1-S(N)(D)(ND)(NI)(NDI)G2R-13-S (G2R-1A3-S)	P2RF-05-E P2RF-05	PCB terminals	P2R-05P, P2R-057P
			Solder terminals	P2R-05A
2 Poles	G2R-2-S(N)(D)(ND)(NI)(NDI)	P2RF-08-E P2RF-08	PCB terminals	P2R-08P, P2R-087P
			Solder terminals	P2R-08A

Note: See Dimensions for details on socket size.

Mounting Track

Applicable socket	Description	Model
Track connecting socket	Mounting track	50 cm (l) x 7.3 mm (t): PFP-50N 1 m (l) x 7.3 mm (t): PFP-100N 1 m (l) x 16 mm (t): PFP-100N2
	End plate	PFP-M
	Spacer	PFP-S
Back connecting socket	Mounting plate	P2R-P*

*Used to mount several P2R-05A and P2R-08A connecting sockets side by side.

Specifications

■ Coil Ratings

Rated voltage		12 VAC	24 VAC	100/(110) VAC	120 VAC	200/(220)VAC	220 VAC	230 VAC	240 VAC
Rated Current	50Hz	93 mA	46.5 mA	11 mA	9.3 mA	5.5 (4.0) mA	5.1 mA	4.7 (3.7) mA	4.7 mA
	60Hz	75 mA	37.5 mA	9/(10.6) mA	7.5 mA	4.5 (5.3) mA	4.1 mA	3.8 (3.1) mA	3.8 mA
Coil resistance		65 Ω	260 Ω	4,600 Ω	6,500 Ω	20,200 (25,000) Ω	25,000 Ω	26,850 (30,000) Ω	30,000 Ω
Coil inductance (H) (ref. value)	Armature OFF	0.19	0.81	13.34	21	51.3	57.5	62	65.5
	Armature ON	0.39	1.55	26.84	42	102	117	124	131
Must operate voltage		80% max. of rated voltage							
Must release voltage		30% min. of rated voltage							
Max. voltage		140% of rated voltage (at 23°C)							
Power consumption		Approx. 0.9 VA at 60 Hz (approx. 0.7 VA at 60 Hz)							

Note: 1. Rated voltage of bifurcated crossbar contact type: 100/(110) VAC, 200/(220) VAC, 230 VAC (Approx. 0.7 VA at 60 Hz).

2. Depending on the type of Relay, some Relays do not have coil specifications. Contact your OMRON representative for more details.

Rated voltage		5 VDC	6 VDC	12 VDC	24 VDC	48 VDC	100 VDC
Rated current (50/60Hz)		106 mA	88.2 mA	43.6 mA	21.8 mA	11.5 mA	5.3 mA
Coil resistance		47 Ω	68 Ω	275 Ω	1,100 Ω	4,170 Ω	18,860 Ω
Coil inductance (H) (ref. value)	Armature OFF	0.20	0.28	1.15	4.27	13.86	67.2
	Armature ON	0.39	0.55	2.29	8.55	27.71	93.2
Must operate voltage		70% max. of rated voltage					
Must release voltage		15% min. of rated voltage					
Max. voltage		170% of rated voltage (at 23°C)					
Power consumption		Approx. 0.53 W					

Note: Rated voltage of bifurcated crossbar contact type: 12 VDC, 24 VDC

High-sensitivity Relays

Rated voltage		5 VDC	6 VDC	12 VDC	24 VDC	48 VDC
Rated current (50/60Hz) (see Note. 1)		71.4 mA	60 mA	30 mA	15 mA	7.5 mA
Coil resistance (see Note. 1)		70 Ω	100 Ω	400 Ω	1,600 Ω	6,400 Ω
Coil inductance (H) (ref. value)	Armature OFF	0.37	0.53	2.14	7.80	31.20
	Armature ON	0.75	1.07	4.27	15.60	62.40
Must operate voltage		70% max. of rated voltage				
Must release voltage		15% min. of rated voltage				
Max. voltage		170% of rated voltage (at 23°C)				
Power consumption		Approx. 0.36 W				

Note: 1. The rated current and coil resistance are measured at a coil temperature of 23°C with a tolerance of $f^{+15\%}/_{-20\%}$ (AC rated current) or $\pm 10\%$ (DC coil resistance)

2. LEDs are used for the built-in operation indicator. For models equipped with these indications, the VAC rated current must be increased by approximately 1 mA; the VDC rated current, by approximately 4 mA.

3. Operating characteristics are measured at a coil temperature of 23°C.

Double-winding Latching Relays

Rated voltage		5 VDC	6 VDC	12 VDC	24 VDC	
Set Coil	Rated current (see note 1.)	167 mA	138 mA	70.6 mA	34.6 mA	
	Coil resistance (see note 1.)	30 Ω	43.5 Ω	170 Ω	694 Ω	
	Coil inductance (H) (ref. value)	Armature OFF	0.073	0.104	0.42	1.74
		Armature ON	0.146	0.208	0.83	3.43
Reset Coil	Rated current	119 mA	100 mA	50 mA	25 mA	
	Coil resistance	42 Ω	60 Ω	240 Ω	960 Ω	
	Coil inductance (H) (ref. value)	Armature OFF	0.003	0.005	0.018	0.079
		Armature ON	0.006	0.009	0.036	0.148
Must set voltage		70% max. of rated voltage				
Must reset voltage		70% max. of rated voltage				
Max. voltage		140% of rated voltage (at 23°C)				
Power consumption		Set coil: Approx. 850 mW; Reset coil: Approx. 600 mW				

- Note: 1. The rated current and coil resistance are measured at a coil temperature of 23°C with a tolerance of ±10%.
 2. Operating characteristics are measured at a coil temperature of 23°C.

■ Contact Ratings

PCB/Flux Protection, Plug-in, Quick-connect Terminal Relays

Item	General-purpose, quick-connect terminal				High-capacity	
Number of poles	1 pole		2 poles		1 pole	
Load	Resistive load (cosφ = 1)	Inductive load (cosφ = 0.4; L/R = 7 ms)	Resistive load (cosφ = 1)	Inductive load (cosφ = 0.4; L/R = 7 ms)	Resistive load (cosφ = 1)	Inductive load (cosφ = 0.4; L/R = 7 ms)
Rated Load	10 (1) A at 250 VAC; 10 (1) A at 30 VDC	7.5 A at 250 VAC; 5 A at 30 VDC	5 A at 250 VAC; 5 A at 30 VDC	2 A at 250 VAC; 3 A at 30 VDC	16 A at 250 VAC; 16 A at 30 VDC	8 A at 250 VAC; 8 A at 30 VDC
Rated carry current	10 (1) A		5 A		16 A	
Max. switching voltage	380 VAC, 125 VDC		380 VAC, 125 VDC		380 VAC, 125 VDC	
Max. switching current	10 (1) A		5 A		16 A	
Max. switching power	2,500 (250) VA, 300 (30) W	1,875 VA, 150 W	1,250 VA, 150 W	500 VA, 90 W	4,000 VA, 480 W	2,000 VA, 240 W
Failure rate (reference value)	100 mA at 5 VDC (1 mA at 5 VDC)		10 mA at 5 VDC		100 mA at 5 VDC	

- Note: 1. P level: λ₆₀ = 0.1 × 10⁻⁶/operation.
 2. (.): Bifurcated crossbar contact type.

PCB/Flux Protection Relays

Item	Bifurcated contacts		High-sensitivity			
	1 pole		1 pole		2 poles	
Number of poles	1 pole		1 pole		2 poles	
Load	Resistive load (cosφ = 1)	Inductive load (cosφ = 0.4; L/R = 7 ms)	Resistive load (cosφ = 1)	Inductive load (cosφ = 0.4; L/R = 7 ms)	Resistive load (cosφ = 1)	Inductive load (cosφ = 0.4; L/R = 7 ms)
Rated Load	5 A at 250 VAC; 5 A at 30 VDC	2 A at 250 VAC; 3 A at 30 VDC	5 A at 250 VAC; 5 A at 30 VDC	2 A at 250 VAC; 3 A at 30 VDC	3 A at 250 VAC; 3 A at 30 VDC	1 A at 250 VAC; 1.5 A at 30 VDC
Rated carry current	5 A		5 A		3 A	
Max. switching voltage	380 VAC, 125 VDC		380 VAC, 125 VDC		380 VAC, 125 VDC	
Max. switching current	5 A		5 A		3 A	
Max. switching power	1,250 VA, 150 W	500 VA, 90 W	1,250 VA, 150 W	500 VA, 90 W	750 VA, 90 W	250 VA, 45 W
Failure rate (reference value)	1 mA at 5 VDC		100 mA at 5 VDC		10 mA at 5 VDC	

Note: P level: $\lambda_{60} = 0.1 \times 10^{-6}$ /operation.

PCB/Fully Sealed Relays

Item	General-purpose (single contact)				Bifurcated contact	
	1 pole		2 poles		1 pole	
Load	Resistive load (cosφ = 1)	Inductive load (cosφ = 0.4; L/R = 7 ms)	Resistive load (cosφ = 1)	Inductive load (cosφ = 0.4; L/R = 7 ms)	Resistive load (cosφ = 1)	Inductive load (cosφ = 0.4; L/R = 7 ms)
Rated Load	8 A at 250 VAC; 8 A at 30 VDC	6 A at 250 VAC; 4 A at 30 VDC	4 A at 250 VAC; 4 A at 30 VDC	1.5 A at 250 VAC; 2.5 A at 30 VDC	5 A at 250 VAC; 5 A at 30 VDC	2 A at 250 VAC; 3 A at 30 VDC
Rated carry current	8 A		4 A		5 A	
Max. switching voltage	380 VAC, 125 VDC		380 VAC, 125 VDC		380 VAC, 125 VDC	
Max. switching current	8 A		4 A		5 A	
Max. switching power	2,000 VA, 240 W	1,500 VA, 120 W	1,000 VA, 120 W	375 VA, 75 W	1,250 VA, 150 W	500 VA, 90 W
Failure rate (reference value)	100 mA at 5 VDC		10 mA at 5 VDC		1 mA at 5 VDC	

Note: P level: $\lambda_{60} = 0.1 \times 10^{-6}$ /operation.

Latching Relays

Number of poles	1 pole		2 poles	
	Resistive load (cosφ = 1)	Inductive load (cosφ = 0.4; L/R = 7 ms)	Resistive load (cosφ = 1)	Inductive load (cosφ = 0.4; L/R = 7 ms)
Rated Load	5 A at 250 VAC; 5 A at 30 VDC	3.5 A at 250 VAC; 2.5 A at 30 VDC	3 A at 250 VAC; 3 A at 30 VDC	1.5 A at 250 VAC; 2 A at 30 VDC
Rated carry current	5 A		3 A	
Max. switching voltage	380 VAC, 125 VDC		380 VAC, 125 VDC	
Max. switching current	5 A		3 A	
Max. switching power	1,250 VA, 150 W	875 VA, 75 W	750 VA, 90 W	375 VA, 60 W
Failure rate (reference value)	100 mA at 5 VDC		10 mA at 5 VDC	

Note: P level: $\lambda_{60} = 0.1 \times 10^{-6}$ /operation.

■ Characteristics

Standard Relays

Item	1 Pole	2 Poles
Contact resistance	30 mΩ max. (high-capacity type: 100 mΩ max.)	50 mΩ max.
Operate (set) time	15 ms max	
Release (reset) time	AC: 10 ms max.; DC: 5 ms max. (w/built-in diode: 20 ms max.)	
Max. operating frequency	Mechanical: 18,000 operations/hr Electrical: 1,800 operations/hr (under rated load)	
Insulation resistance	1,000 MΩ min. (at 500 VDC)	
Dielectric strength	5,000 VAC, 50/60 Hz for 1 min between coil and contacts*; 1,000 VAC, 50/60 Hz for 1 min between contacts of same polarity	5,000 VAC, 50/60 Hz for 1 min between coil and contacts*; 3,000 VAC, 50/60 Hz for 1 min between contacts of different polarity 1,000 VAC, 50/60 Hz for 1 min between contacts of same polarity
Vibration resistance	Destruction: 10 to 55 to 10 Hz, 0.75mm single amplitude (1.5mm double amplitude) Malfunction: 10 to 55 to 10 Hz, 0.75mm single amplitude (1.5mm double amplitude)	
Shock resistance	Destruction: 1,000 m/s ² Malfunction: 200 m/s ² when energized; 100 m/s ² when not energized	
Endurance	Mechanical: AC coil: 10,000,000 operations min.; DC coil: 20,000,000 operations min. (at 18,000 operations/hr) Electrical: 100,000 operations min. (at 1,800 operations/hr under rated load)	
Ambient temperature	Operating: -40°C to 70°C (with no icing)	
Ambient humidity	Operating: 5% to 85%	
Weight	Approx. 17 g (plug-in terminal: approx. 20 g)	

Note: Values in the above table are the initial values.

*2,000 VAC, 50/60 Hz for 1 minute when the P2R-05A or P2R-08A socket is mounted.

Double-winding Latching Relays

Item	1 Pole	2 Poles
Contact resistance	30 mΩ max.	50 mΩ max.
Set time	20 ms max	
Reset time	20 ms max.	
Min. set/reset signal width	30 ms max.	
Max. operating frequency	Mechanical: 18,000 operations/hr Electrical: 1,800 operations/hr (under rated load)	
Insulation resistance	1,000 MΩ min. (at 500 VDC)	
Dielectric strength	5,000 VAC, 50/60 Hz for 1 min between coil and contacts*; 1,000 VAC, 50/60 Hz for 1 min between contacts of same pole; 1,000 VAC, 50/60 Hz for 1 min between set and reset coil	5,000 VAC, 50/60 Hz for 1 min between coil and contacts*; 3,000 VAC, 50/60 Hz for 1 min between contacts of different poles 1,000 VAC, 50/60 Hz for 1 min between contacts of same pole 1,000 VAC, 50/60 Hz for 1 min between set and reset coil
Vibration resistance	Destruction: 10 to 55 to 10 Hz, 0.75mm single amplitude (1.5mm double amplitude) Malfunction: 10 to 55 to 10 Hz, 0.75mm single amplitude (1.5mm double amplitude)	
Shock resistance	Destruction: 1,000 m/s ² (approx. 100G) Malfunction: Set: 500 m/s ² (approx. 50G); 200 m/s ² (approx. 20G) Reset: 100 m/s ² (approx. 10G)	
Endurance	Mechanical: 10,000,000 operations min (at 18,000 operations/hr) Electrical: 100,000 operations min. (at 1,800 operations/hr under rated load)	
Ambient temperature	Operating: -40°C to 70°C (with no icing)	
Ambient humidity	Operating: 5% to 85%	
Weight	Approx. 17 g	

Note: Values in the above table are the initial values.

*2,000 VAC, 50/60 Hz for 1 minute when the P2R-05A or P2R-08A socket is mounted.

■ Approved Standards

UL 508 (File No. E41643)

Model	Contact form	Coil ratings	Contact ratings
G2R-1 G2R-14 G2R-1-H G2R-1-S G2R-1-T	SPDT	3 to 110 VDC 3 to 240 VAC	10 A, 30 VDC (resistive) 10 A, 250 VAC (general use) TV-3 (NO contact only)
G2R-1A G2R-1A4 G2R-1A-H G2R-1A-S G2R-1A-T	SPST-NO		
G2R-1-E	SPDT		16 A, 30 VDC (resistive, NO contact only) 16 A, 250 VAC (general use, NO contact only)
G2R-1A-E	SPST-NO		TV-3 (NO contact only); 1/3 hp, 120 VAC
G2R-2 G2R-24 G2R-2-H G2R-2-S	DPDT		5 A, 30 VDC (resistive) 5 A, 250 VAC (general use) TV-3 (NO contact only)
G2R-2A G2R-2A4 G2R-2A-H G2R-2A-S	DPST-NO		
G2R-1A-ASI	SPST-NO		10 A, 30 VDC (resistive) 10 A, 250 VAC (general use) TV-5/TV-8 (NO contact only)

CSA 22.2 No.0, No.14 (File No. LR31928)

Model	Contact form	Coil ratings	Contact ratings
G2R-1 G2R-14 G2R-1-H G2R-1-S G2R-1-T	SPDT	3 to 110 VDC 3 to 240 VAC	10 A, 30 VDC (resistive) 10 A, 250 VAC (general use) TV-3 (NO contact only)
G2R-1A G2R-1A4 G2R-1A-H G2R-1A-S G2R-1A-T	SPST-NO		
G2R-1-E	SPDT		16 A, 30 VDC (resistive, NO contact only) 16 A, 250 VAC (general use, NO contact only)
G2R-1A-E	SPST-NO		TV-3 (NO contact only)
G2R-2 G2R-24 G2R-2-H G2R-2-S	DPDT		5 A, 30 VDC (resistive) 5 A, 250 VAC (general use) TV-3 (NO contact only)
G2R-2A G2R-2A4 G2R-2A-H G2R-2A-S	DPST-NO		
G2R-1A-ASI	SPST-NO		10 A, 30 VDC (resistive) 10 A, 250 VAC (general use) TV-8 (NO contact only); 1/4 hp, 125 VAC

SEV

Contact form	Coil ratings	Contact ratings
1 pole	3 to 110 VDC 3 to 240 VAC	16 A, 250 VAC1 (AgSnIn contact) 16 A, 30 VDC1 (AgSnIn contact) 10 A, 250 VAC1 5 A, 250 VAC3 10 A, 30 VDC1
2 poles	3 to 110 VDC 3 to 240 VAC	5 A, 250 VAC1 2 A, 380 VAC1 5 A, 30 VDC1

SEMKO

Contact form	Coil ratings	Contact ratings
1 pole	3 to 110 VDC 3 to 240 VAC	10/80 A, 250 VAC 3/100 A, 250 VAC 16/128 A, 250 VAC (AgSnIn contact)
2 poles		5/40 A, 250 VAC

TÜV (IEC 255)

Contact form	Coil ratings	Contact ratings
1 pole	3 to 110 VDC, 6 VAC to 240 VAC (for Standard coil) 3 to 48 VDC (for K, U coil) 3 to 70 VDC (for H coil)	10 A, 250 VAC ($\cos\phi = 1.0$) 10 A, 30 VDC (0 ms) 16 A, 250 VAC ($\cos\phi = 1.0$) (AgSnIn contact)
2 poles		8 A, 250 VAC ($\cos\phi = 0.4$) 5 A, 250 VAC ($\cos\phi = 1.0$) 5 A, 30 VDC (0 ms) 2.5 A, 250 VAC ($\cos\phi = 0.4$)

EN 61810-1 (VDE IEC 255, VDE 0435 IMQ - VDE Reg No. 6166)

Contact form	Coil ratings	Contact ratings
1 pole	5, 6, 9, 12, 18, 24, 48, 60, 100, 110 VDC 12, 18, 24, 48, 50, 100/(110), 110, 120, 200/(220), 220, 230, 240 VAC	10 A, 250 VAC ($\cos\phi = 1.0$) 10 A, 30 VDC (0 ms) 16 A, 250 VAC ($\cos\phi = 1.0$)
2 poles	5, 6, 9, 12, 18, 24, 48, 60, 100, 110 VDC 12, 18, 24, 48, 50, 100/(110), 110, 120, 200/(220), 220, 230, 240 VAC	5 A, 250 VAC ($\cos\phi = 1.0$) 5 A, 30 VDC (0 ms)

Engineering Data

Maximum Switching Power

Flux Protection/Plug-in Relays G2R-1, G2R-1A, G2R-1-S, G2R-1-T, G2R-1A-T

G2R-1-E, G2R-1A-E

G2R-1Z, G2R-1AZ

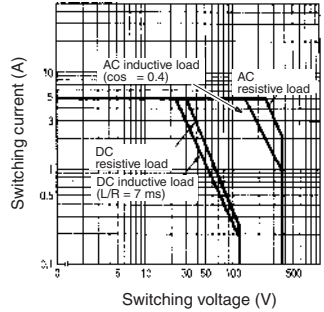
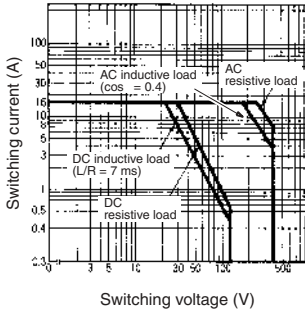
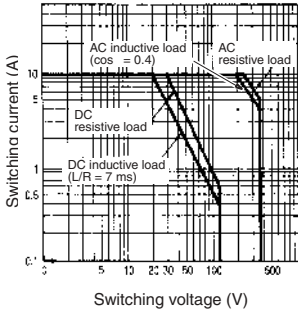

G2R-1-H, G2R-1A-H, G2R-2
G2R-2A, G2R-2-S

G2R-2-H, G2R-2A-H

G2R-13-S, G2R-1A3-S

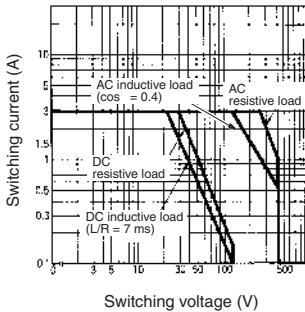
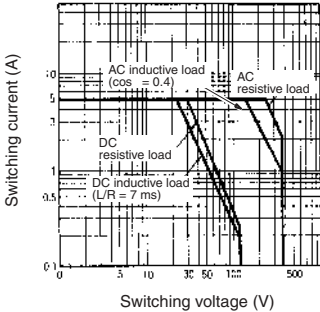

G2RK-1A, G2RK-1

G2RK-2A, G2RK-2

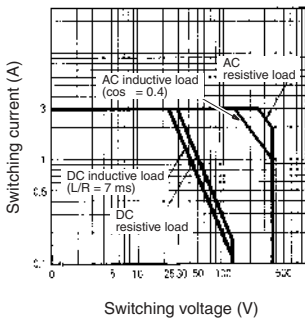
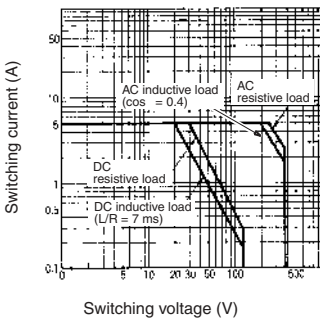

Engineering Data (cont.)

Fully Sealed Relays
G2R-14, G2R-1A4

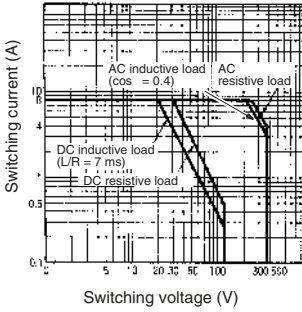

G2R-24, G2R-2A4

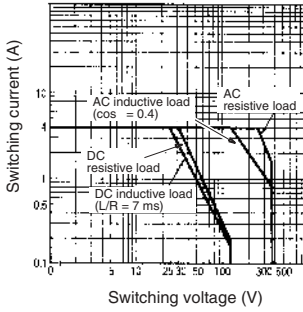

G2R-1Z4, G2R-1AZ4

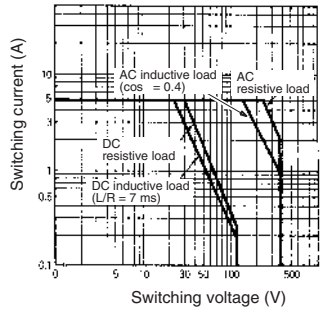

Endurance

Flux Protection/Plug-in Relays
G2R-1, G2R-1A, G2R-1-S, G2R-1-T, G2R-1A-T

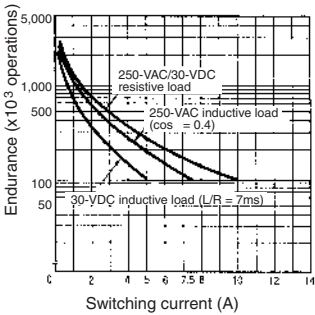

G2R-1-E, G2R-1A-E

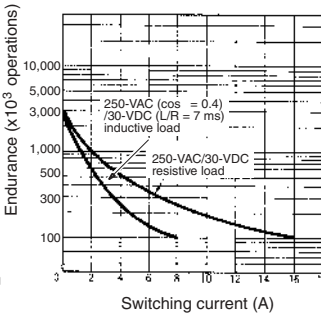

G2R-1Z, G2R-1AZ

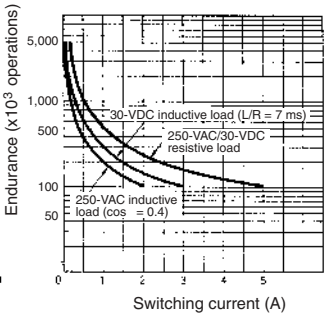

G2R-1-H, G2R-1A-H, G2R-2
G2R-2A, G2R-2-S

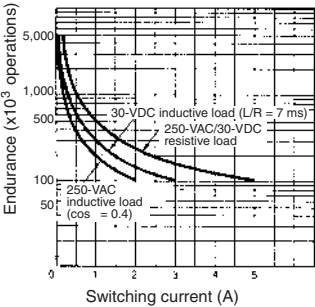

G2R-2-H, G2R-2A-H

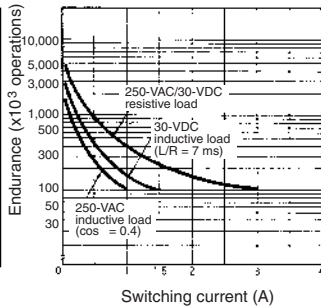

G2R-13-S, G2R-1A3-S

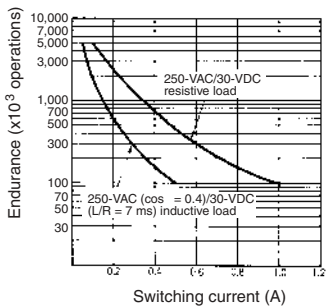

G2RK-1A, G2RK-1

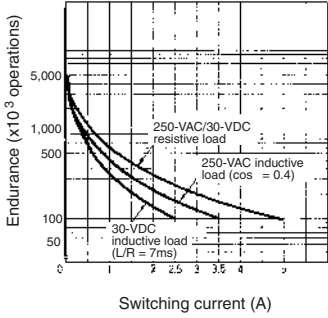

G2RK-2A, G2RK-2

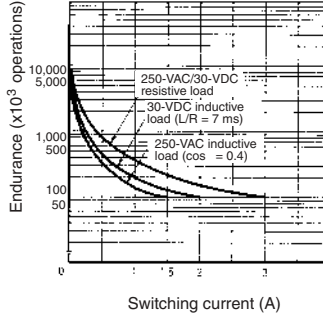

Fully sealed Relays
G2R-14, G2R-1A4

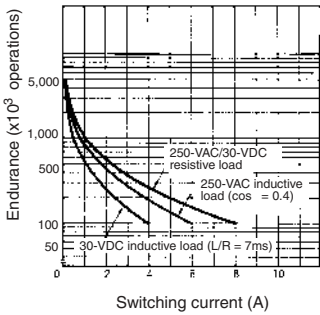

G2R-24, G2R-2A4

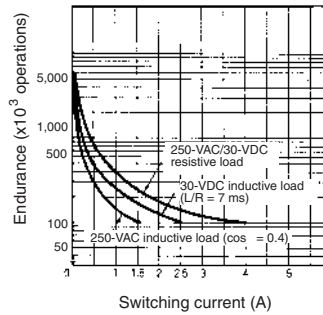

G2R-1Z4, G2R-1AZ4

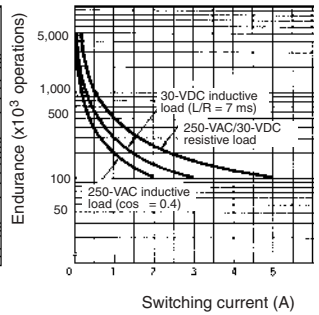

Ambient Temperature vs Maximum Coil Voltage

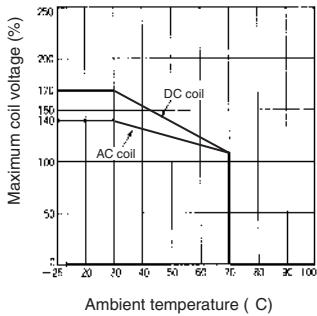

Note: The maximum coil voltage refers to the maximum value in a varying range of operating power voltage, not a continuous voltage.

Dimensions

- Note: 1. All units are in millimeters unless otherwise indicated.
- 2. Orientation marks are indicated as follows:

Relays with PCB Terminals

SPDT Relays G2R-1, G2R-1Z, G2R-1-H

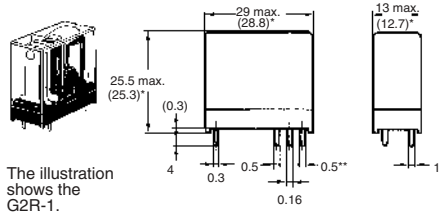

*Average value
**0.3 (-H Type)

Terminal Arrangement/ Internal Connections (Bottom View)

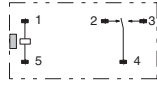

Mounting Holes (Bottom View)

Tolerance: 0.1

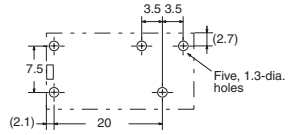

(No coil polarity)

SPST-NO Relays G2R-1A, G2R-1AZ, G2R-1A-H

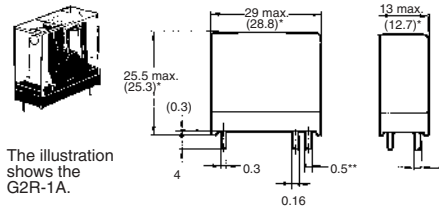

*Average value
**0.3 (-H Type)

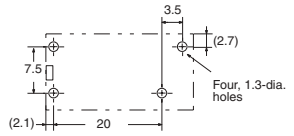

(No coil polarity)

SPDT/High-capacity Relays G2R-1-E

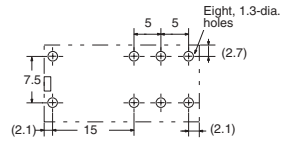
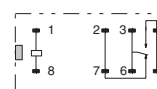
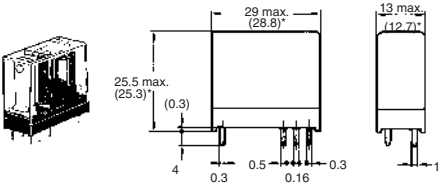

(No coil polarity)

SPST-NO/High-capacity Relays G2R-1A-E

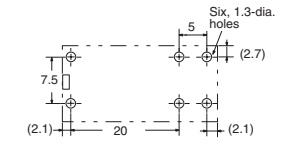
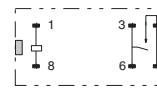
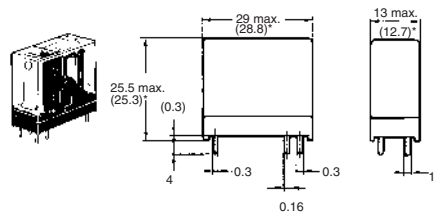

(No coil polarity)

Relays with PCB Terminals

SPDT Relays
G2R-14, G2R-1Z4

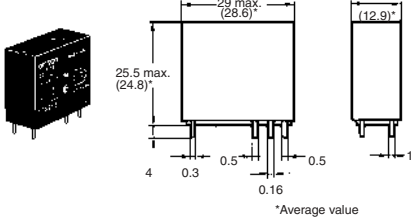

**Terminal Arrangement/
Internal Connections
(Bottom View)**

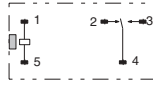

**Mounting Holes
(Bottom View)**

Tolerance: ±0.1

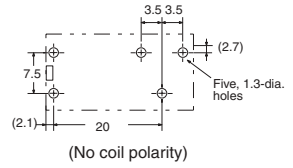

SPST-NO Relays
G2R-1A4, G2R-1AZ4

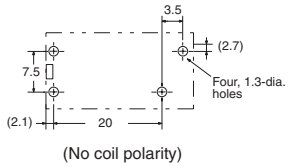
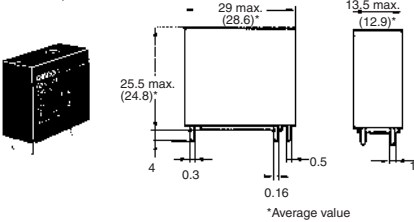

Relays with Plug-in Terminals

SPDT Relays
G2R-1-S, G2R-1-SD, G2R-1-SN, G2R-1-SND, G2R-1-SNI, G2R-1-SNDI
G2R-13-S, G2R-13-SD, G2R-13-SN, G2R-13-SND

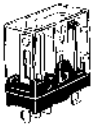

*This terminal is SPDT only.

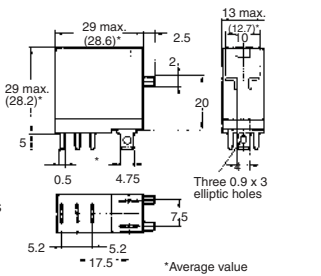

**Terminal Arrangement/Internal Connections
(Bottom View)**

G2R-1-S, G2R-13-S

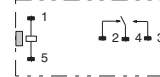

G2R-1-SN, G2R-1-SNI,
G2R-13-SN (AC)

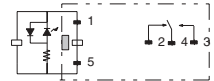

G2R-1-SN, G2R-1-SNI,
G2R-13-SN (DC)

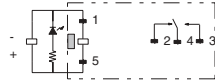

G2R-1-SD, G2R-13-SD
(DC)

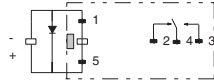

G2R-1-SND, G2R-1-SNDI,
G2R-13-SND (DC)

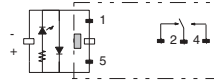

(After confirming coil
polarity, wire correctly.)
(Except G2R-1-S,
G2R-13-S)

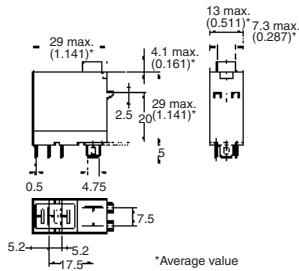

Dimensions

DPDT Relays

G2R-2-S, G2R-2-SD, G2R-2-SN, G2R-2-SNI, G2R-2-SNDI
G2R-2-SND

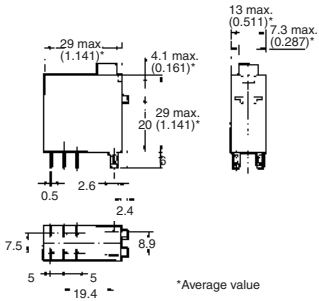
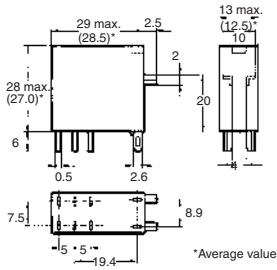

Terminal Arrangement/Internal Connections
(Bottom View)

G2R-2-S

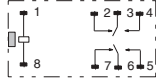

G2R-2-SN G2R-2-SNI (AC)

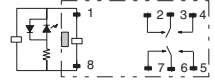

G2R-2-SN G2R-2-SNI (DC)

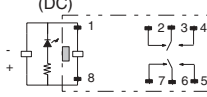

G2R-2-SD (DC)

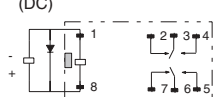

G2R-2-SND G2R-2-SNDI (DC)

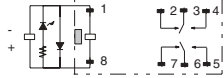

(After confirming coil polarity, wire correctly.)

Relays with PCB Terminals

DPDT Relays
G2R-2, G2R-2-H

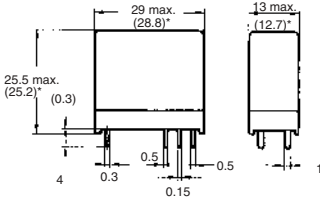
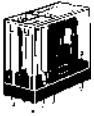

*Average value

Terminal Arrangement/
Internal Connections
(Bottom View)

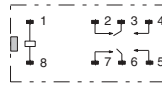

Mounting Holes
(Bottom View)

Tolerance: 0.1

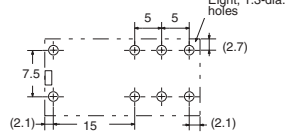

(No coil polarity)

DPST-NO Relays
G2R-2A, G2R-2A-H

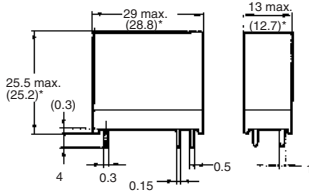

*Average value

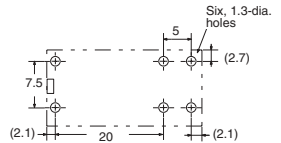
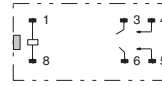

(No coil polarity)

DPDT Relays
G2R-24

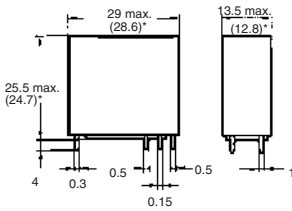

*Average value

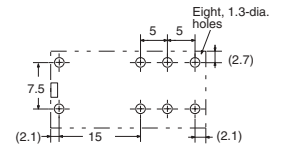
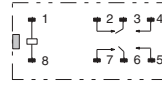

(No coil polarity)

DPST-NO Relays
G2R-2A4

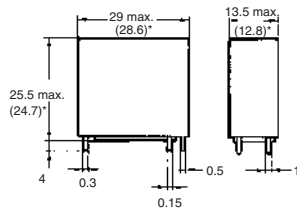
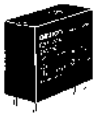

*Average value

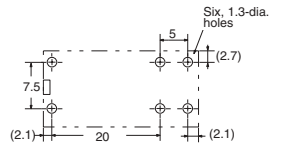
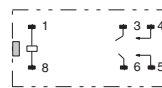

(No coil polarity)

Double-winding Latching Relays with PCB Terminals

SPDT Relays
G2R-1

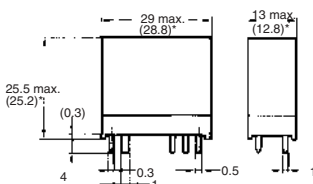

*Average value

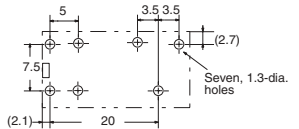
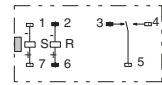

(After confirming coil polarity, wire correctly.)

Double-winding Latching Relays with PCB Terminals

SPST-NO Relays
G2RK-1A

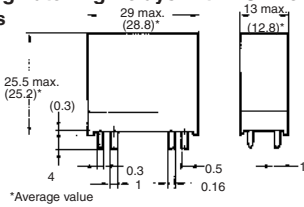

*Average value

Terminal Arrangement/
Internal Connections
(Bottom View)

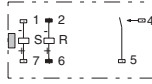

Mounting Holes
(Bottom View)

Tolerance: 0.1

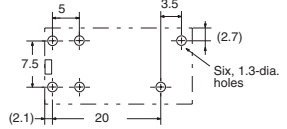

(After confirming coil polarity, wire correctly.)

DPDT Relays
G2RK-2

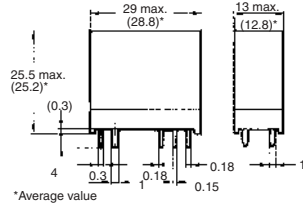
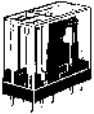

*Average value

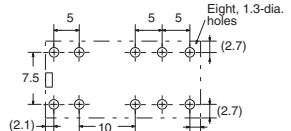
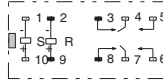

(After confirming coil polarity, wire correctly.)

DPST-NO Relays
G2RK-2A

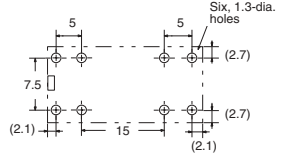
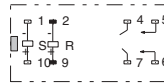
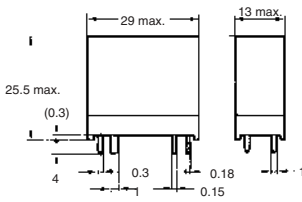
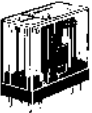

(After confirming coil polarity, wire correctly.)

Relays with Quick-connect Terminals

SPDT Relays
G2R-1-T

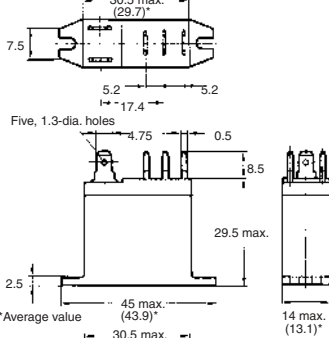
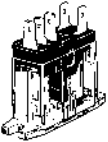

*Average value

Terminal Arrangement/Internal Connections
(Bottom View)

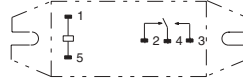

(No coil polarity)

Mounting Holes (Bottom View)

Tolerance: 0.1

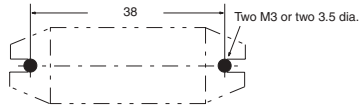

SPST-NO Relays
G2R-1A-T

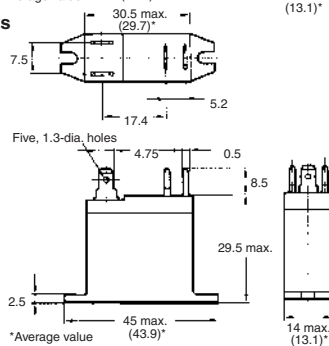
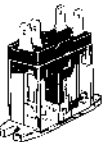

*Average value

Terminal Arrangement/Internal Connections
(Bottom View)



(No coil polarity)

Mounting Holes (Bottom View)

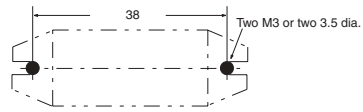

Note: Model number of quick-connect terminal is 187.

Track/Surface Mounting Sockets
P2RF-05-E

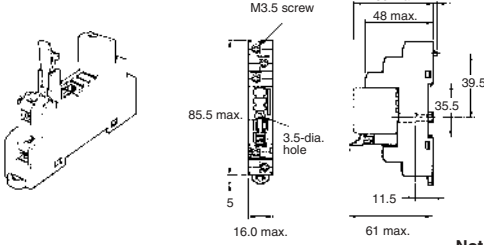

Terminal Arrangement
(Top View)

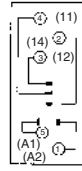

Mounting Holes
(for Surface Mounting)

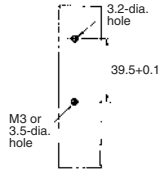

Note: Pin numbers in parentheses apply to DIN standard.

P2RF-08-E

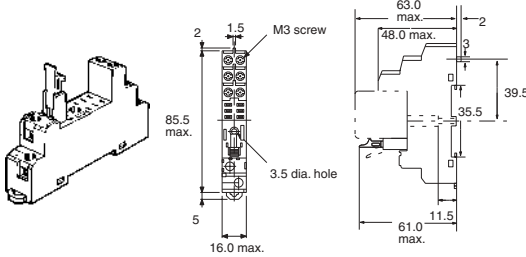

Terminal Arrangement
(Top View)

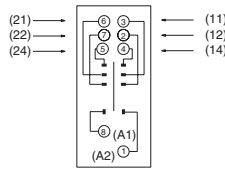

Mounting Holes
(for Surface Mounting)

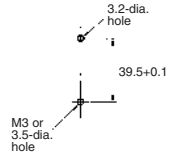

P2RF-05

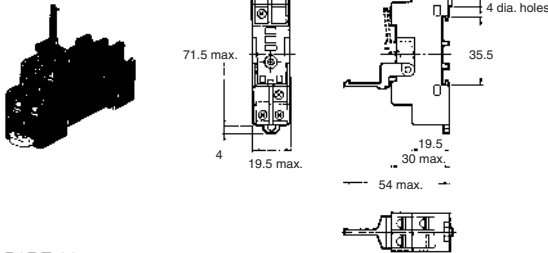

Terminal Arrangement



Mounting Holes
(for Surface Mounting)

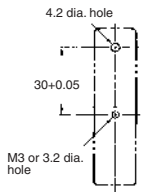

P2RF-08

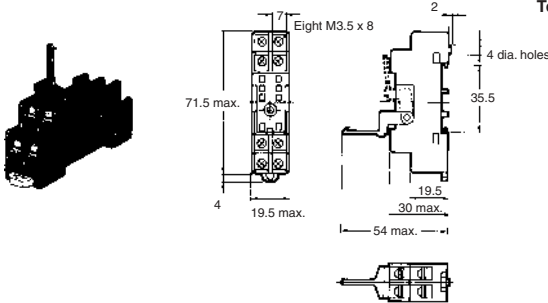

Terminal Arrangement

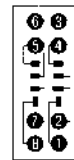

Mounting Holes
(for Surface Mounting)

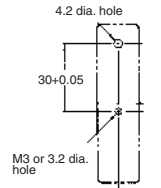

Back Connecting Sockets
P2R-05P (1-pole)

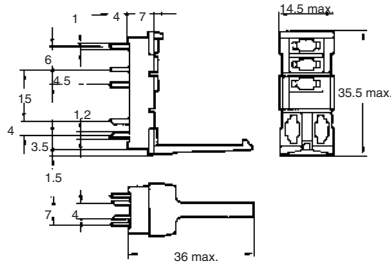
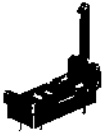

Terminal Arrangement



Mounting Holes

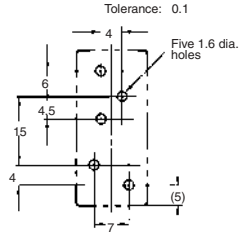

P2R-08P (2-pole)

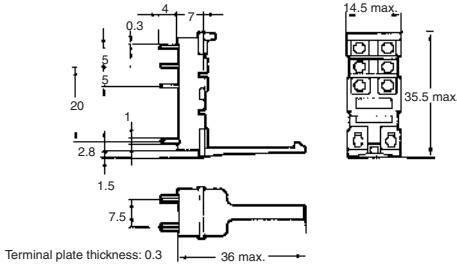

Terminal Arrangement

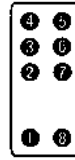

Mounting Holes

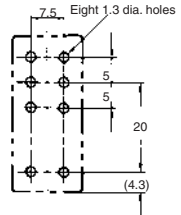

P2R-05A (1-pole)

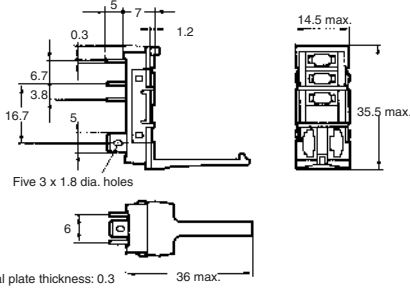

Terminal Arrangement



Panel Cutout



P2R-08A (2-pole)

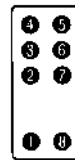
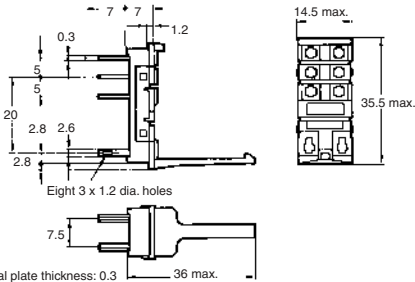

Mounting Height of Relay with Socket

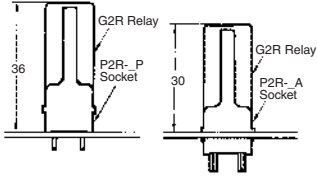

Mounting Track
PFP-100N, PFP-50N

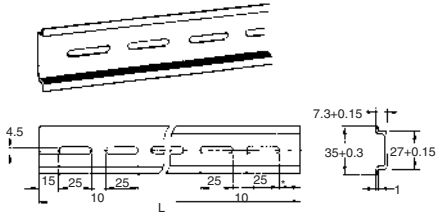

PFP-100N2

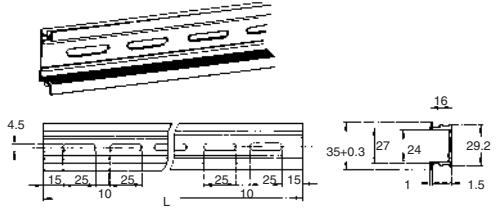

It is recommended to use a panel 1.6 to 2.0 mm thick.

L: Length

1 m	PFP-100N
50 cm	PFP-50N
1 m	PFP-100N2

End Plates
PFP-M

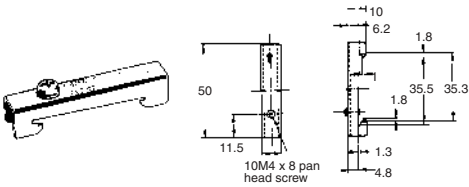

Spacers
PFP-S

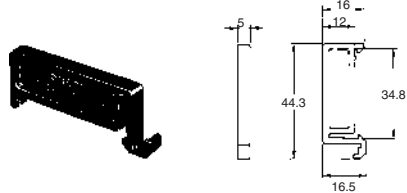

Mounting Plates
P2R-P

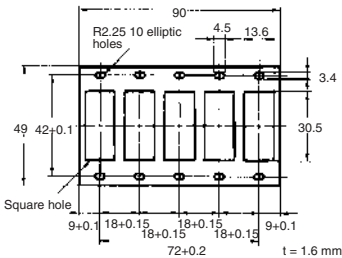

Precautions

■ Mounting

When mounting a number of relays on a PCB, be sure to provide a minimum mounting space of 5 mm between the two juxtaposed relays as shown below.

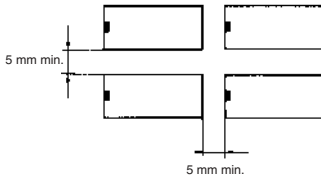

The above minimum mounting space is necessary due to mutual thermal interference generated by the relays. This restriction may be ignored, however, depending on the operating conditions of the relays. Consult OMRON for details.

There is no restriction on the mounting direction of each relay on the PCB.

When using this circuit, confirm the set and reset states and then take into account the circuit constant.

ALL DIMENSIONS SHOWN ARE IN MILLIMETERS.

To convert millimeters into inches, multiply by 0.03937. To convert grams into ounces, multiply by 0.03527.

**Next-generation PCB Relay
Available in 24 Models**

- ROHS compliant.
- Low profile: 15.7 mm max. in height.
- Conforms to EN 61810-1, UL508 and CSA22.2.
- Meets VDE0700 requirements for household products according to VDE0110.
- Clearance and creepage distance: 10mm/10mm.
- Tracking distance: CT>250 (Both standard and class F type).
- UL 1446 Class F Coil Insulation system available.
- High sensitivity: 400 mW



Ordering Information

Classification		Enclosure ratings	Contact form			
			SPST-NO	SPDT	DPST-NO	DPDT
Standard	General-purpose	Flux protection	G2RL-1A	G2RL-1	G2RL-2A	G2RL-2
		Fully sealed	G2RL-1A4	G2RL-14	G2RL-2A4	G2RL-24
	High-capacity	Flux protection	G2RL-1A-E	G2RL-1-E	---	---
		Fully sealed	G2RL-1A4-E	G2RL-14-E	---	---
Class-F	General-purpose	Flux protection	G2RL-1A-CF	G2RL-1-CF	G2RL-2A-CF	G2RL-2-CF
		Fully sealed	G2RL-1A4-CF	G2RL-14-CF	G2RL-2A4-CF	G2RL-24-CF
	High-capacity	Flux protection	G2RL-1A-E-CF	G2RL-1-E-CF	---	---
		Fully sealed	G2RL-1A4-E-CF	G2RL-14-E-CF	---	---

Note: When ordering, add the rated coil voltage to the model number.

Example: G2RL-1A 12 VDC
 _____ Rated coil voltage

Model Number Legend

G2RL-□□□-□-□
 1 2 3 4 5

1. Number of Poles

- 1: 1 pole
- 2: 2 poles

2. Contact Form

- None: PDT
- A: PST-NO

3. Enclosure Ratings

- None: Flux protection
- 4: Fully sealed

4. Classification

- None: General purpose
- E: High capacity (1 pole)

5. Approved Standards

- None: UL, CSA, VDE, UL Class B Insulation
- CF: UL, CSA, VDE, UL Class F Insulation

Specifications

■ Coil Ratings

Rated voltage	5 VDC	12 VDC	24 VDC	48 VDC
Rated current	80.0 mA	33.3 mA	16.7 mA	8.96 mA
Coil resistance	62.5 Ω	360 Ω	1,440 Ω	5,358 Ω
Must operate voltage	70% max. of the rated voltage			
Must release voltage	10% min. of the rated voltage			
Max. voltage	130% at 85°C of the rated voltage			
Power consumption	Approx. 400 mW			Approx. 430 mW

Note: The rated current and coil resistance are measured at a coil temperature of 23°C with a tolerance of ±10%.

■ Contact Ratings

Number of poles	1 pole	2 poles
Contact material	AgSnO ₂	AgNi
Load	Resistive load (cosφ=1)	Resistive load (cosφ=1)
Rated load	12 A (16 A) at 250 VAC 12 A (16 A) at 24 VDC (See note 2.)	8 A at 250 VAC 8 A at 30 VDC (See note 2.)
Rated carry current	12 A (16 A) (See note 2.)	8 A (70°C)/5 A (85°C) (See note 2.)
Max. switching voltage	440 VAC, 300 VDC	
Max. switching current	12 A (16 A)	8 A
Max. switching power	3,000 VA (4,000 VA)	2,000 VA

- Note:** 1. Values in parentheses are those for the high-capacity model.
2. Contact your OMRON representative for the ratings on fully sealed models.

■ Characteristics

Item	1 pole	2 poles
Contact resistance	100 mΩ max.	
Operate (set) time	15 ms max. (Approx. 7 ms typical)	
Release (reset) time	5 ms max. (Approx. 2 ms typical)	
Max. operating frequency	Mechanical: 18,000 operation/hr Electrical: 1,800 operation/hr at rated load	
Insulation resistance	1,000 MΩ min. (at 500 VDC)	
Dielectric strength	5,000 VAC, 1 min between coil and contacts 1,000 VAC, 1 min between contacts of same polarity	5,000 VAC, 1 min between coil and contacts 2,500 VAC, 1 min between contacts of different polarity 1,000 VAC, 1 min between contacts of same polarity
Impulse withstand voltage	10 kV (1.2×50 μs) between coil and contact	
Vibration resistance	Destruction: 10 to 55 to 10 Hz, 0.75 mm single amplitude (1.5 mm double amplitude) Malfunction: 10 to 55 to 10 Hz, 0.75 mm single amplitude (1.5 mm double amplitude)	
Shock resistance	Destruction: 1,000 m/s ² Malfunction: Energized: 100 m/s ² Not energized: 100 m/s ²	
Endurance (Mechanical)	20,000,000 operations (at 18,000 operations/hr)	
Ambient temperature	Operating: -40°C to 85°C (with no icing) Storage: -40°C to 85°C (with no icing)	
Ambient humidity	5% to 85%	
Weight	Approx. 12 g	
Packaging	Standard: 20 relays/stick	

Note: Values in the above table are the initial values.

■ Approved Standards

UL508 (File No. E41643)

Model	Contact form	Coil ratings	Contact ratings
G2RL-1A	SPST-NO	3 to 48 VDC	12 A at 250 VAC (General use) 12 A at 24 VDC (Resistive)
G2RL-1	SPDT		
G2RL-1A-E	SPST-NO (High capacity)		16 A at 250 VAC (General use) 16 A at 24 VDC (Resistive)
G2RL-1-E	SPDT (High capacity)		
G2RL-2A	DPST-NO		8 A at 277 VAC (General use) 8 A at 30 VDC (Resistive)
G2RL-2	DPDT		

CSA C22.2 (No. 14) (File No. LR31928)

Model	Contact form	Coil ratings	Contact ratings
G2RL-1A	SPST-NO	3 to 48 VDC	12 A at 250 VAC (General use) 12 A at 24 VDC (Resistive)
G2RL-1	SPDT		
G2RL-1A-E	SPST-NO (High capacity)		16 A at 250 VAC (General use) 16 A at 24 VDC (Resistive)
G2RL-1-E	SPDT (High capacity)		
G2RL-2A	DPST-NO		8 A at 277 VAC (General use) 8 A at 30 VDC (Resistive)
G2RL-2	DPDT		

EN 61810-1 (VDE 0435) (Licence No. 119650)

Model	Contact form	Coil ratings	Contact ratings
G2RL	1 pole	5, 12, 18, 22, 24, 48 VDC	12 A at 250 VAC ($\cos\phi=1$) 12 A at 24 VDC (L/R=0 ms) AC15: 3 A at 240 VAC DC13: 2.5 A at 24 VDC, 50 ms
	1 pole (High capacity)		16 A at 250 VAC ($\cos\phi=1$) 16 A at 24 VDC (L/R=0 ms) AC15: 3 A at 240 VAC (NO) 1.5 A at 240 VAC (NC) DC13: 2.5 A at 24 VDC (NO), 50 ms
	2 poles		8 A at 250 VAC ($\cos\phi=1$) 8 A at 24 VDC (L/R=0 ms) AC15: 1.5 A at 240 VAC DC13: 2 A at 30 VDC, 50 ms

Engineering Data

Maximum Switching Capacity

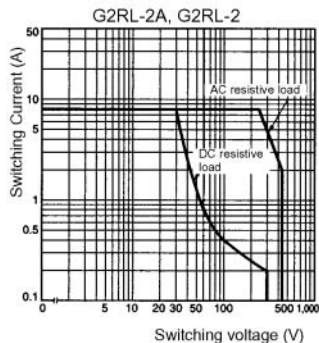
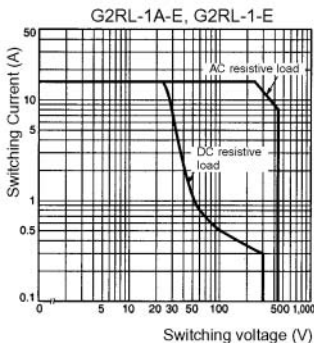
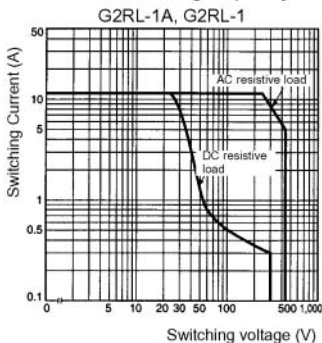

Ambient Temperature vs Rated Carry Current

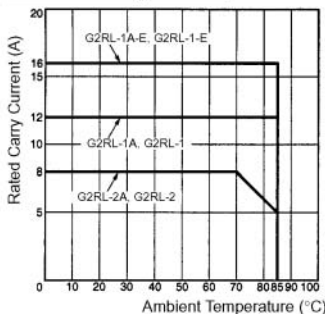

Ambient Temperature vs Maximum Coil Voltage

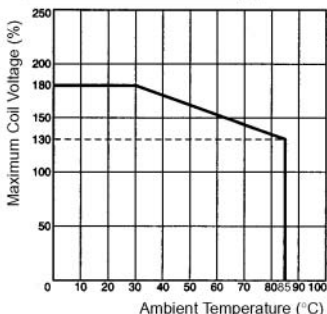

Note: The maximum coil voltage refers to the maximum value in a varying range of operating power voltage, not a continuous voltage.

Note: Contact your OMRON representative for the data on fully sealed models.

Electrical Endurance Data

G2RL-1-E	16 A at 250 VAC ($\cos\phi=1$) 16 A at 24 VDC 8 A at 250 VAC ($\cos\phi=0.4$) 8 A at 30 VDC ($L/R=7$ ms)	30,000 operations min. 30,000 operations min. 200,000 operation min. (Normally open side operation) 10,000 operation min. (Normally open side operation)
G2RL-1	12 A at 250 VAC ($\cos\phi=1$) 12 A at 24 VDC 5 A at 250 VAC ($\cos\phi=0.4$) 5 A at 30 VDC ($L/R=7$ ms)	50,000 operations min. 30,000 operations min. 150,000 operation min. (Normally open side operation) 20,000 operation min. (Normally open side operation)
G2RL-2	8 A at 250 VAC ($\cos\phi=1$) 8 A at 30 VDC	30,000 operations min. 30,000 operations min.
G2RL-1A-E	Pilot duty (A300), 250 VAC Pilot duty (A300), 125 VAC	250,000 operations min. 150,000 operations min.

Note: The results shown reflect values measured using very severe test conditions i.e., Duty: 1 sec ON/1 sec OFF.
Electrical endurance will vary depending on the test conditions. Contact your OMRON representative if you require more detailed information for the electrical endurance under your test conditions.

Dimensions

Note: All units are in millimeters unless otherwise indicated.

G2RL-1A, G2RL-1A4

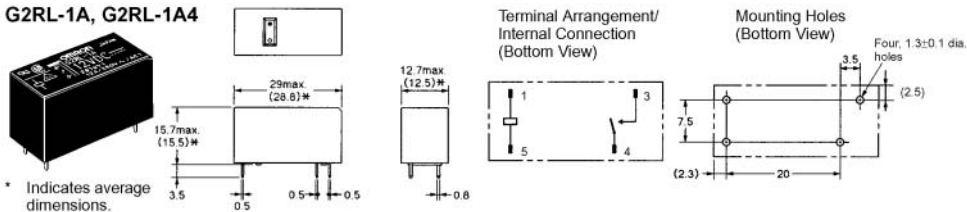

G2RL-1, G2RL-14

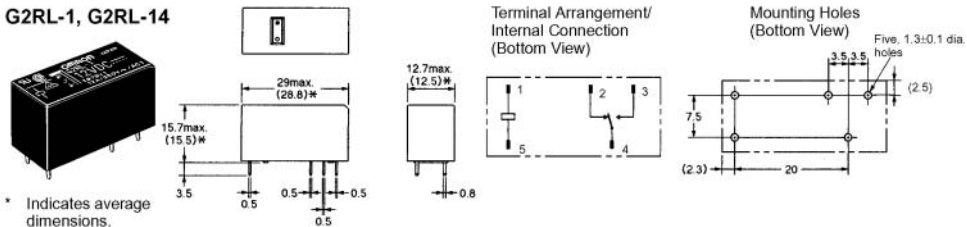

G2RL-1A-E, G2RL-1A4-E

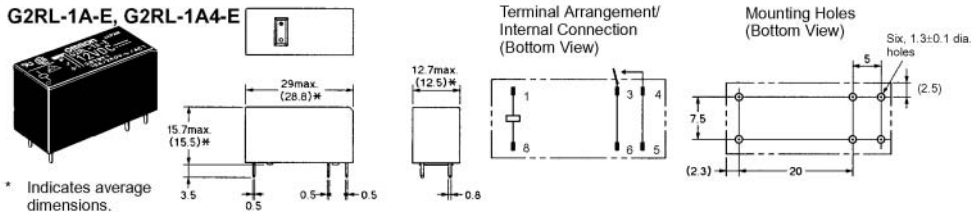

G2RL-1-E, G2RL-14-E

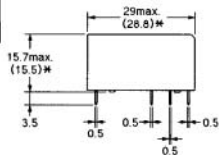
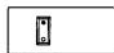

* Indicates average dimensions.

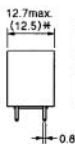
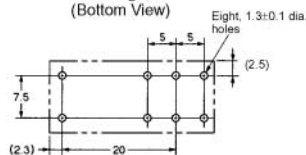
Terminal Arrangement/
Internal Connection
(Bottom View)Mounting Holes
(Bottom View)

G2RL-2A, G2RL-2A4

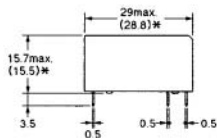

* Indicates average dimensions.

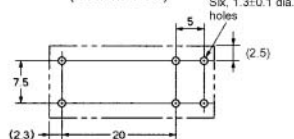
Terminal Arrangement/
Internal Connection
(Bottom View)Mounting Holes
(Bottom View)

G2RL-2, G2RL-24

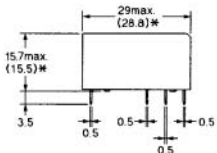
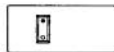

* Indicates average dimensions.

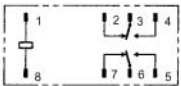
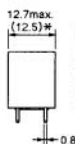
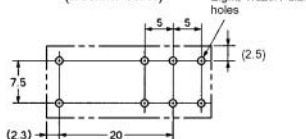
Terminal Arrangement/
Internal Connection
(Bottom View)Mounting Holes
(Bottom View)

Precautions

Basic Information

Before actually committing any component to a mass-production situation, OMRON strongly recommends situational testing, in as close to actual production situations as possible. One reason is to confirm that the product will still perform as expected after surviving the many handling and mounting processes involved in mass production. Also, even though OMRON relays are individually tested a number of times, and each meets strict requirements, a certain testing tolerance is permissible. When a high-precision product uses many components, each depends upon the rated performance thresholds of the other components. Thus, the overall performance tolerance may accumulate into undesirable levels. To avoid problems, always conduct tests under the actual application conditions.

General

To maintain the initial characteristics of a relay, exercise care that it is not dropped or mishandled. For the same reason, do not remove the case of the relay; otherwise, the characteristics may degrade. Avoid using the relay in an atmosphere containing sulfuric acid (SO₂), hydrogen sulfide (H₂S), or other corrosive gases. Do not continuously apply a voltage higher than the rated maximum voltage to the relay. Never try to operate the relay at a voltage and a current other than those rated.

Do not use the relay at temperatures higher than that specified in the catalog or data sheet.

A Single-pole 16A Power Relay AC-coil Type

- L 29.0 x W 12.7 x H 15.7 (mm)
Low profile: 15.7mm in height.
- Standards class F insulation available.
- Clearance and creepage distance between coil and contact: 8mm / 8mm, between the same pole 3mm / 4mm.
- An environmentally friendly product – Cd, Pb and Chromium free.



Ordering Information

Classification		Enclosure ratings	Contact form	
			SPST-NO	SPDT
Class F	High-capacity	Flux protection	-	G5RL-1-E

Note: When ordering, add the rated coil voltage to the number.

Example: G5RL-1-E 100 VAC

_____ Rated coil voltage

Model Number Legend

G5RL- -
 1 2 3 4

1. Number of Poles

1: 1 pole

2. Contact Form / Contact Construction

None: 1c / SPDT

3. Enclosure Ratings

None: Flux protection

4. Classification

E: High capacity

Specifications

■ Coil Ratings

Rated voltage	24 VAC	100 VAC	115 VAC / 120 VAC		200 VAC	230 VAC / 240 VAC	
Rated current 50Hz (mA)	31.30	7.50	5.85	6.25	3.75	3.00	3.13
Rated current 60Hz (mA)	28.30	6.88	5.35	5.70	3.45	2.76	2.88
Coil resistance Ω	443.00	8220.00	11600.00		33000.00	47600.00	
Must operate voltage	75% max. of rated voltage						
Must release voltage	15% min. of rated voltage						
Max. voltage	90% ~ 110% of rated voltage						
Power consumption	Approx. 75 VA						

- Note: 1. The above items are measured at a coil temperature of 23.
 2. The tolerance of rated current is +15% / -20%.
 3. Power consumption drop was measured at 50Hz.
 4. Coil resistance is provided as reference values.

■ Contact Ratings

Load	Resistive load ($\cos \phi=1$)
Rated load	AC250V 16A (N.O.), DC 24V 16A (N.O.), AC 250V 5A (N.C.), DC24V 5A (N.C.)
Rated carry current	16A (N.O.), 5A (N.C.)
Max. switching voltage	AC 250V, DC24V
Max. switching current	16A (N.O.), 5A (N.C.)
Max. switching capacity	AC 4000 VA (N.O.), AC 1250 VA (N.C.), DC384 W(N.O.), DC120 W (N.C.)
Min. permissible load	DC 24V 40mA

■ Approved Standards

UL 508 (File No. E41643 Vol.4 Sec.38) / CSA C22.2 No.1, C22.2 No.14
 (Certificate No:1419093)

Model	Coil ratings	Contact ratings
G5RL-1-E	24VAC to 240 VAC	16 A, 277 VAC General, 50,000 c - NO 16 A, 250 VAC General, 50,000 c - NO TV-5, 25,000 c - NO A 300 Pilot Duty, 720 VA, 240 VAC, 30,000 c - NO $\frac{1}{2}$ Hp, 120 VAC, 6,000 c - NO 60 LRA/ 10 FLA, 250 VAC, 6,000 c - NO 5 A, 250 VAC General, 50,000 c - NC 5 A, 24 VDC Resistive, 50,000 c - NC

DIN EN 61810-1/EN 60255-23 (VDE Reg. No. A282)

Model	Coil ratings	Contact ratings
G5RL-1-E	24,100,115/120, 200, 230/240 VAC (50Hz)	16A, 250 VAC, 16A 24 VDC

■ Characteristics

Contact resistance	100 mΩ max.
Operate time	15 ms max.
Release time	5 ms max.
Max. switching frequency	Mechanical: 18,000 operations/hr Electrical: 1,800 operations/hr (under rated load)
Insulation resistance	1,000MΩ min. (at 500VDC)
Dielectric strength	1,000 VAC, 50/60 Hz for 1 min. between contacts of same polarity 6,000 VAC, 50/60 Hz for 1 min. between coil and contacts
Impulse withstand voltage	10,000V between coil and contacts, 1.2 X 50 μsec
Vibration resistance	Destruction: 10 to 55 to 10Hz, 1.5 mm double amplitude Malfunction: 10 to 55 to 10Hz, 1.5 mm double amplitude
Shock resistance	Destruction: 1,000 m/s ² (approx. 100G) Malfunction: 100 m/s ² (approx. 10G)
Life expectancy	Mechanical: 10,000,000 operations min. (at 18,000 operations/hr) Electrical: 50,000 operations min. (at 1,800 operations/hr, Resistive load 16A 250VAC N.O.) (at 1,800 operations/hr, Resistive load 16A 24VDC N.O.) (at 1,800 operations/hr, Resistive load 5A 250VAC N.C.) (at 1,800 operations/hr, Resistive load 5A 24VDC N.C.) 100,000 operations min. (at 1,800 operations/hr, Resistive load 12A 24VDC N.O.)
Ambient temperature	Operating: -40°C to 70°C
Ambient humidity	Operating: 5% to 85% RH
Weight Approx.	10 g

Dimensions

Note: All units are in millimeters unless otherwise indicated.

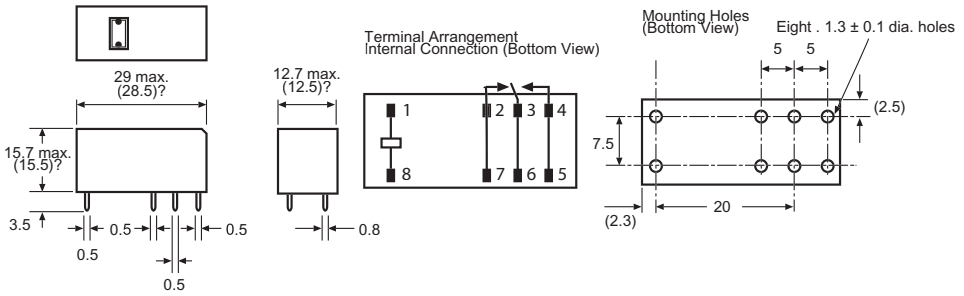

Packaging

Note: All units are in millimeters unless otherwise indicated.

Polystyrene Trays Packing

1 Polystyrene: 100 pcs relay

1 Sleeve Packing: 5 polystyrene tray

1 Carton: 2 sleeve packing – 1000 pcs relay

Weight: Approx. 12 Kg per carton

Size of polystyrene tray is approximately: 340 (L) x 120 (W) x 48 (H)

Size of Carton box is approximately: 535 (L) x 355 (W) x 250 (H)

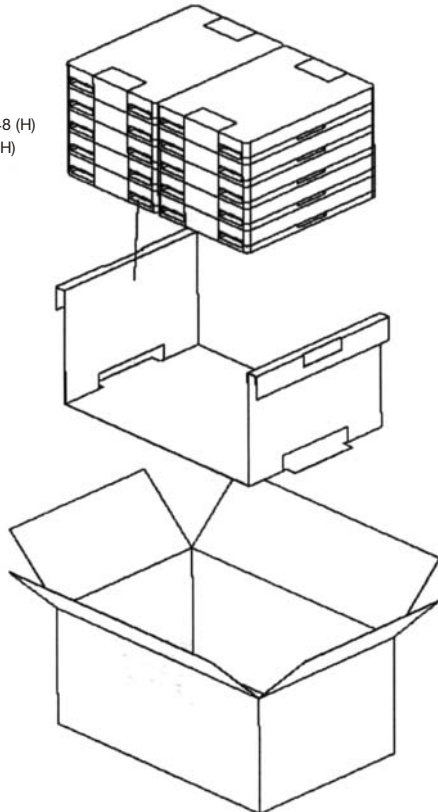

Impulse Withstand Voltage as High as 10 kV with 4kV Dielectric Strength: Ideal for Power Supply Switching

- Creepage distance of 8 mm min.
- Dielectric strength of 4,000 VAC min.
- SPST-NO types conform to TV-8 rating.
- DPST-NO types conform to TV-5 rating.
- International 2.54mm terminal pitch.



Ordering Information

Contacts		SPST-NO	DPST-NO
Mounting style	Terminals		
General purpose	PCB (straight)	G4W-1112P-US-TV8	G4W-2212P-US-TV5
Upper mounting	Solder	G4W-11123A-US-TV8	G4W-22123A-US-TV5
	Quick-connect	G4W-11123T-US-TV8	G4W-22123T-US-TV5

Note: When ordering, add the rated coil voltage to the model number.
 Example: G4W-11123A-US-TV8 12 VDC
 _____ Rated coil voltage

Model Number Legend

G4W - - - - VDC
 1 2 3 4 5 6 7 8 9

- | | | |
|---|--|---|
| <p>1. Contact Form
 11: SPST-NO
 22: DPST-NO</p> <p>2. Contact Type
 1: Single button</p> <p>3. Enclosure Ratings
 2: Unsealed</p> | <p>4. Mounting Style
 None: Standard
 3: Upper mounting bracket</p> <p>5. Terminals
 P: Straight PCB
 A: Solder
 T: Quick connect</p> <p>6. Approved Standards
 US: UL, CSA certified</p> | <p>7. TV Ratings
 TV5: TV-5
 TV8: TV-8</p> <p>8. Special Function
 None: General-purpose
 Z: Full-wave rectifier</p> <p>9. Rated Coil Voltage
 12, 24, 100 VDC</p> |
|---|--|---|

Specifications

■ Coil Ratings

Single-side Stable Type

Rated voltage	12 VDC	24 VDC	100 VDC
Rated current	66.7 mA	33.3 mA	8 mA
Coil resistance	180 Ω	720 Ω	12,500 Ω
Coil inductance (H) (ref. value)	Armature OFF	0.93	61.8
	Armature ON	1.65	106
Must operate voltage	80% max. of rated voltage		
Must release voltage	10% min. of rated voltage		
Max. voltage	130% of rated voltage (at 23°C)		
Power consumption	Approx. 800 mW		

Note: 1. The rated current and coil resistance are measured at a coil temperature of 23°C with a tolerance of ±15%.

2. Operating characteristics are measured at a coil temperature of 23°C.

■ Contact Ratings

Item	SPST-NO		DPST-NO	
	Resistive load ($\cos\phi = 1$)	Inductive load ($\cos\phi = 0.4$; L/R = 7 ms)	Resistive load ($\cos\phi = 1$)	Inductive load ($\cos\phi = 0.4$; L/R = 7 ms)
Rated load	15A at 250 VAC; 15A at 24 VDC	10A at 250 VAC; 7.5A at 24 VDC	10A at 250 VAC; 10A at 24 VDC;	7.5A at 250 VAC; 5A at 24 VDC
Contact material	AgCdO (Cd free planned 1 Apr 05)			
Rated carry current	15A		10A	
Max. switching voltage	250 VAC, 125 VDC			
Max. switching current	15A		10A	
Max. switching power	3,750 VA, 375 W	2,500 VA, 255 W	2,500 VA, 240 W	1,850 VA, 120 W
Failure rate (reference value)	100 mA at 5 VDC			

■ Characteristics

Contact resistance	30 mΩ max.
Operate time	20 ms max. (mean value: approx. 13 ms)
Release time	5 ms max. (mean value: approx. 2.5 ms)
Bounce time	Operate: approx. 3 ms
Max. Operating Frequency	Mechanical: 18,000 operations/hr Electrical: 1,800 operations/hr (under rated load)
Insulation resistance	100 MΩ max. (at 500 VDC)
Dielectric strength	4,000 VAC, 50/60 Hz for 1 min between coil and contacts 2,000 VAC, 50/60 Hz for 1 min between contacts of different polarities (DPST-NO) 1,500 VAC, 50/60 Hz for 1 min between contacts of same polarity
Impulse withstand voltage	10,000 V (1.2 x 50 μs) between coil and contacts
Vibration resistance	Destruction: 10 to 55 to 10 Hz, 0.75mm single amplitude (1.5mm double amplitude) Malfunction: 10 to 55 to 10 Hz, 0.75mm single amplitude (1.5mm double amplitude)
Shock resistance	Destruction: 1,000 m/s ² Malfunction: 150 m/s ²
Endurance	Mechanical: 5,000,000 operations min. (at 18,000 operations/hr) Electrical: 100,000 operations min. (at 1,800 operations/hr)
Ambient temperature	Operating: -25°C to 55°C (with no icing)
Ambient humidity	Operating: 5% to 85% RH
Weight	Approx. 29 g

■ Approved Standards

UL508 (File No. E41643)/CSA C22.2 No.14 (File No.LR31928)

Model	Contact Form	Coil ratings	Contact ratings
G4W-1112P-US-TV8 G4W-11123A-US-TV8 G4W-11123T-US-TV8	SPST-NO	6 to 120 VDC	15 A, 250 VAC (general use) 15 A, 24 VDC TV-8 1/2 hp, 125 VAC 1 hp, 250 VAC 3/4 hp, 240 VAC
G4W-2212P-US-TV5 G4W-22123A-US-TV5 G4W-22123T-US-TV5	DPST-NO		15 A, 250 VAC (general use) 10 A, 250 VAC (general use) 15 A, 24 VDC TV-5 1/2 hp, 250 VAC 1/3 hp, 125/250 VAC

SEMKO (File No. 9346122, 9223128)

Contact form	Coil ratings	Contact ratings
SPST-NO	6-100 VDC	15/120 A, 250 VAC
DPST	6-120 VDC	10/80 A, 250 VAC

EN 61810-1 (VDE0435 (File No. 1906, No. 1907)

Contact form	Coil ratings	Contact ratings
SPST-NO	6, 12, 24, 48, 100 VDC	15 A, 250 VAC ($\cos\phi = 1.0$) 10 A, 250 VAC ($\cos\phi = 0.4$) 15 A, 24 VDC (0 ms) 7.5 A, 24 VDC (40 ms)
DPST-NO		10 A, 250 VAC ($\cos\phi = 1.0$) 7.5 A, 250 VAC ($\cos\phi = 0.4$) 10 A, 24 VDC (0 ms) 5 A, 24 VDC (40 ms)

Engineering Data

Maximum Switching Power

G4W-1112P-US-TV8/-11123A-US-TV8/-11123T-US-TV8

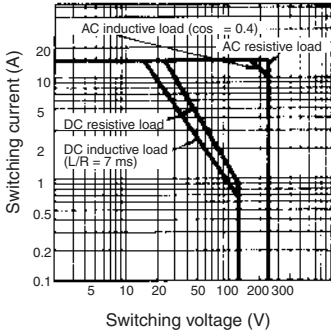

G4W-2212P-US-TV5/-22123A-US-TV5/-22123T-US-TV5

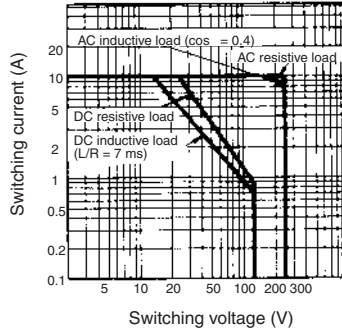

Endurance

G4W-1112P-US-TV8/-11123A-US-TV8/-11123T-US-TV8

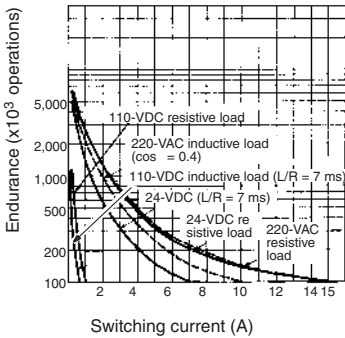

G4W-2212P-US-TV5/-22123A-US-TV5/-22123T-US-TV5

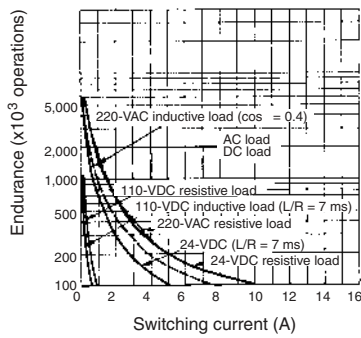

Ambient Temperature vs. Maximum Coil Voltage

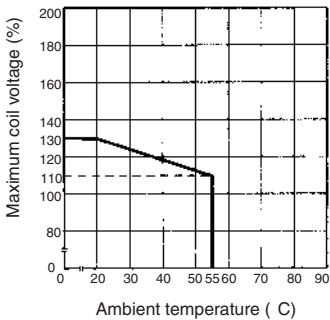

Note: The maximum coil voltage refers to the maximum value in a varying range of operating power voltage, not a continuous voltage.

Dimensions

G4W-□12P-US-TV

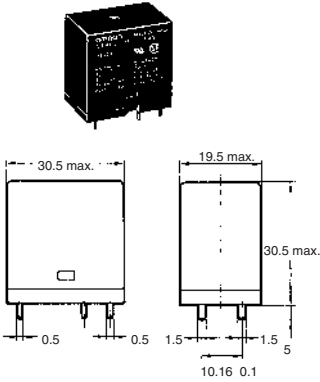

Mounting Holes (Bottom View)
G4W-1112P-US-TV-8

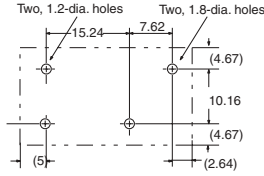

Terminal Arrangement/Internal Connections (Bottom View)

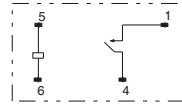

G4W-2212P-US-TV-5

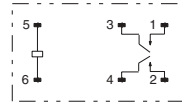
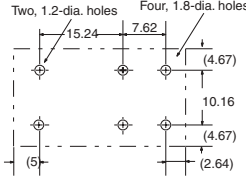

G4W-□123A-US-TV

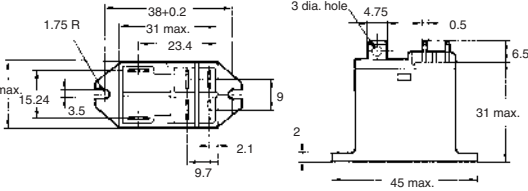
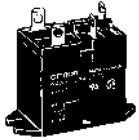

Terminal Arrangement/Internal Connections (Bottom View)
G4W-11123A-US-TV-8



G4W-11123T-US-TV-8



G4W-□123T-US-TV

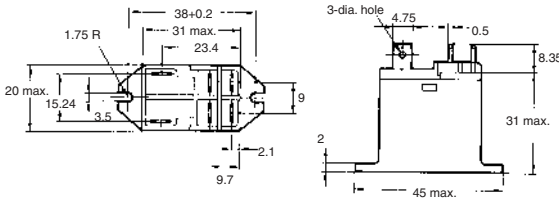
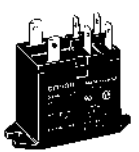

G4W-22123A-US-TV5
G4W-22123T-US-TV5



Mounting Holes (Bottom View)
Tolerance: 0.2

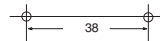

Compact, Low-cost 30-A Power Relay for PC Board or Panel-mounted Applications

- Compact, yet capable of switching up to 30-A loads.
- Complies with UL873 and UL508 column A spacings (1/8" through air, 1/4" over surface).
- UL Class F insulation standard.
- Withstands of up to 6,000 V under 1.250 μs impulse wave or ring wave.
- A selection of contact forms: SPDT and SPST-NO.
- Quick-connect terminals versions ideal for PC board and panel mounting.
- Flanged mounting available.
- Ideal for home and industrial appliances, HVAC (heating, ventilating, and air conditioning), and many other applications.



Ordering Information

Classification		Contact Form	Enclosure Rating		
Mounting style	Terminals		Open	Unsealed	Fully Sealed
PCB mounting	PCB	SPST-NO	G8P-1AP	G8P-1A2P	G8P-1A4P
		SPDT	G8P-1CP	G8P-1C2P	G8P-1C4P
		SPST-NO	G8P-1ATP	G8P-1A2TP	G8P-1A4TP
		SPDT	G8P-1CTP	G8P-1C2TP	G8P-1C4TP
Flanged mounting	Quick-connect	SPST-NO	–	G8P-1A2T-F	–
		SPDT	–	G8P-1C2T-F	–

Note: 1. The contacts described above are AgCdO.
 2. When ordering, add the rated coil voltage to the model number
 Example: G8P-1AP 12 VDC



Model Number Legend

G8P - - VDC
 1 2 3 4 5 6

1. Number of Poles

1: 1 pole

2. Contact Form

A: SPST-NO
 C: SPDT

3. Enclosure Ratings

None: Open
 2: Unsealed
 4: Fully-Sealed

4. Terminals

P: Straight PCB for contacts and coil
 T: Quick-connect (#250 terminals for contacts and #187 terminals for coil)
 TP: Quick-connect (#250 terminals) and straight PCB for contacts, and straight PCB for coil

5. Mounting

None: PCB mounting
 F: Flanged mounting

6. Rated Coil Voltage

5, 9, 12, 24, 48, 110
 Other rated coil voltages available.

Specifications

■ Coil Ratings

Rated voltage	5 VDC	9 VDC	12 VDC	24 VDC	48 VDC	110 VDC
Rated current	185 mA	93 mA	77 mA	36 mA	19 mA	9 mA
Coil resistance	27 Ω	97 Ω	155 Ω	660 Ω	2,480 Ω	12,400 Ω
Must operate voltage	75% max. of rated voltage					
Must release voltage	10% min. of rated voltage					
Max. voltage	120% of rated voltage					
Power consumption	Approx. 900 mW					

Note: The rated current and coil resistance are measured at a coil temperature of 23°C with tolerances of ±10%.

■ Contact Ratings

Item	SPST-NO	SPDT
Load	Resistive load (cosφ = 1)	
Rated load	30 A at 250 VAC; 20 A at 28 VDC	20 A/10 A* at 250 VAC; 20 A/10 A* at 28 VDC
Contact material	AgCdO (Cd free planned 1 Apr 05)	
Rated carry current	30 A	20 A/10 A*
Max. switching voltage	250 VAC, 28 VDC	
Max. switching current	AC: 30 A, DC: 20 A	AC: 20 A/10 A, DC: 20 A/10 A*
Max. switching capacity	7,500 VA, 560 W	5,000/2,500 VA, 560/280 W*

Note: *NO contact/NC contact.

■ Characteristics

	100 mΩ max.
Operate time	15 ms max.
Release time	10 ms max.
Max. Operating Frequency	Mechanical: 18,000 operations/hr Electrical: 360 operations/hr (under rated load)
Insulation resistance	100 MΩ min. (at 500 VDC)
Dielectric strength	2,500 VAC, 50/60 Hz for 1 min between coil and contacts 1,500 VAC, 50/60 Hz for 1 min between contacts of same polarity
Impulse withstand voltage	6,000 V (1.2/50 μs) between coil and contacts
Vibration resistance	Destruction: 10 to 55 to 10 Hz, 0.825-mm single amplitude (1.65-mm double amplitude) for 2 hours Malfunction: 10 to 55 to 10 Hz, 0.825-mm single amplitude (1.65-mm double amplitude) for 5 minutes
Shock resistance	Destruction: 1,000 m/s ² (approx. 100G) Malfunction: 100 m/s ² (approx. 10G)
Endurance	Mechanical: 10,000,000 operation min. (at 18,000 operations/hr) Electrical: 100,000 operations min. (at rated load)
Ambient temperature	Operating: -55°C to 105°C (with no icing)
Ambient humidity	Operating: 5% to 85%
Weight	G8P-1CP: Approx. 21 g, G8P-1CTP: Approx. 24 g G8P-1C4P: Approx. 28 g, G8P-1C4TP: Approx. 31 g

■ Approved Standards
 UL (File No. E41643)/CSA (File No. LR34815-101)
 EN 61810-1 (VDE Reg No. 40004714)

Type	Contact form	Coil ratings	Contact ratings
G8P-1A	SPST-NO	5 to 110 VDC	30 A, 277 VAC (G.P./Res.) 30 A, 250 VAC, 100 k ops. (Res.) 20 A, 120-240 VAC, 70°C, 100 k ops. (G.P./Res.) 20 A, 28 VDC (Res.) 20 A, 240 VAC, 105°C, 100 k ops. (Res.) 1 hp, 125-250 VAC 2 hp, 250 VAC A300 Pilot Duty 12FLA/72LRA, 250 VAC, 100 k ops. 20 FLA/96 LRA, 125 VAC, 100 k ops. 5 A, 250 VAC (Tungsten) 20 A, 120-277 VAC (Ballast) 25A, 250VAC
G8P-1C	SPDT	5 to 110 VDC	30 A/30 A, 250 VAC (Res.) 30 A/30 A, 277 VAC, 40°C, 100 k ops (NO) and 50 k ops (NC) 20 A/15 A, 120-240 VAC, 105°C, 100 k ops. (Res.) 20 A/10 A, 120-240 VAC, 70°C, 100 k ops. (G.P./Res.) 20 A/10 A, 28 VDC (Res.) 1/2 hp/ 1/2 hp, 125 VAC, 100 k ops. 2 hp/ 1/2 hp, 250 VAC 1 hp/ 1/4 hp, 125 VAC B150 Pilot Duty 5 A/3 A, 250 VAC (Tungsten) 6 A/3 A, 277 VAC (Ballast)

Engineering Data

Maximum Switching capacity

SPST-NO

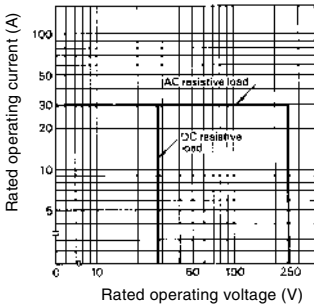

SPDT

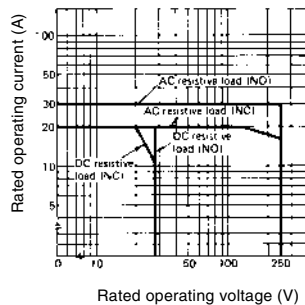

Endurance

SPST-NO

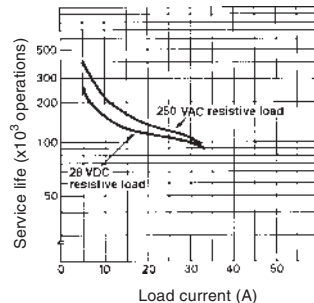

SPDT

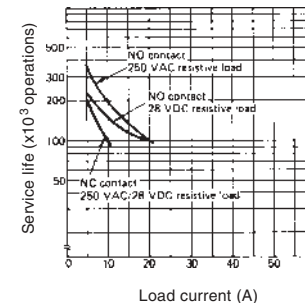

Dimensions

Note: All units are in millimeters unless otherwise indicated.

■ Open Types

G8P-1CP/1AP

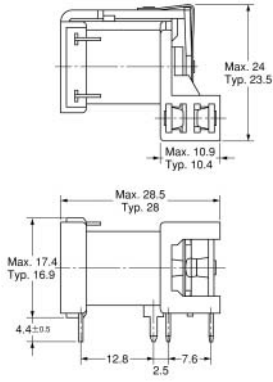

Terminal Arrangement/Internal Connections (Bottom View)

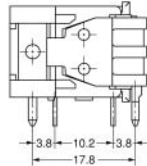
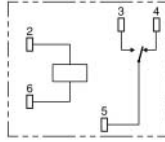

Mounting Holes (Bottom View)

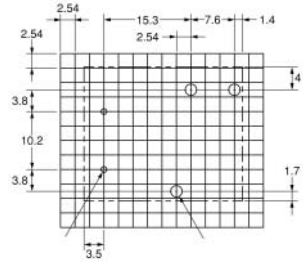

Note: Pin #4 is omitted on G8P-1AP.

G8P-1CTP/1ATP

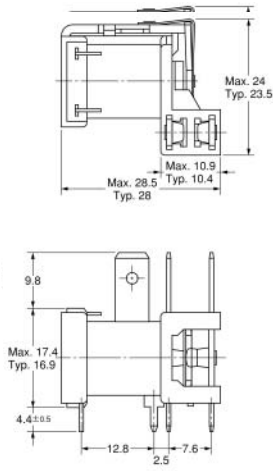

Terminal Arrangement/Internal Connections (Bottom View)

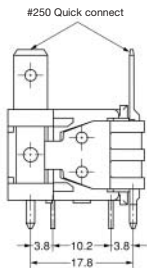
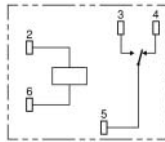

Mounting Holes (Bottom View)

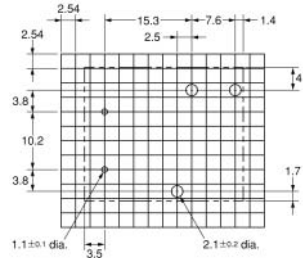

Note: Pin #4 is omitted on G8P-1ATP.

■ Fully-Sealed Types/Unsealed Types

G8P-1C4P/1A4P/1C2P/1A2P

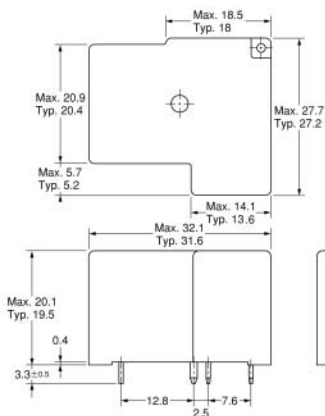

Terminal Arrangement/Internal Connections (Bottom View)

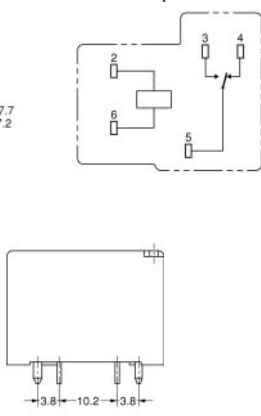

Mounting Holes (Bottom View)

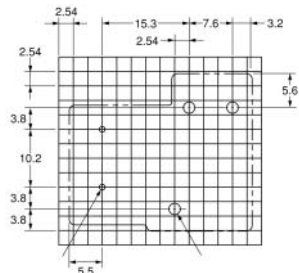

Note: Pin #4 is omitted on G8P-1A4P/1A2P

G8P-1C4TP/1A4TP/1C2TP/1A2TP

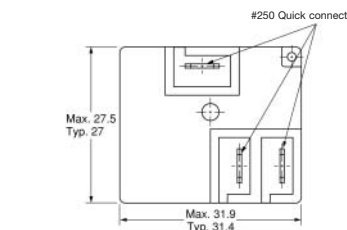

Terminal Arrangement/Internal Connections (Bottom View)

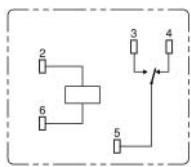

Mounting Holes (Bottom View)

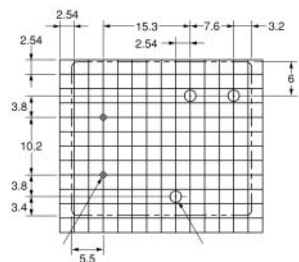

Note: Pin #4 is omitted on G8P-1A4TP/1A2TP

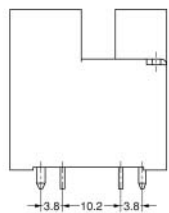
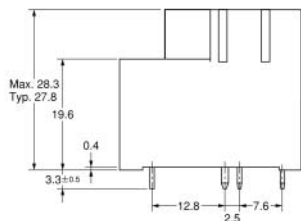

■ Flange Mounting Types

G8P-1C2T-F/1A2T-F

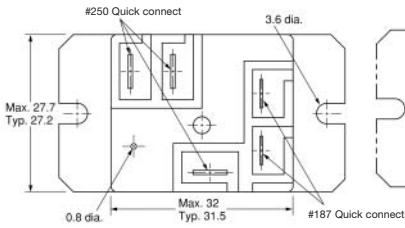

Terminal Arrangement/Internal Connections (Bottom View)

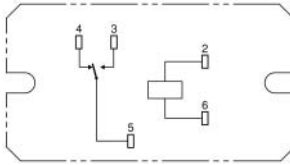

Mounting Holes (Bottom View)

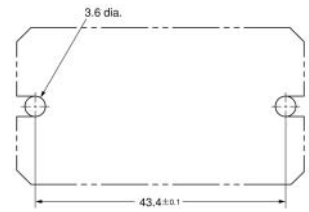

Note: Pin #4 is omitted on G8P-1A2T-F

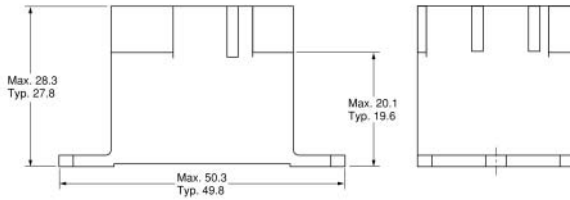

Note: Allow air circulation within the sealed type G8P by removing the knock off nib from the cover after soldering and cleaning is complete.

Precautions

Sealed Relays

Remove the vent hole tape seal from the cover after all soldering and cleaning have been completed to allow air circulation within sealed G8P Relays.

Miniature Single-pole Relay with 80-A Surge Current and 20-A Switching Current

- ROHS compliant.
- Ideal for motor switching.
- Miniature, relay with high switching power and long endurance.
- Creepage distance conforms to UL, CSA and EN standards.
- Highly noise-resistive insulation materials employed.
- Standard model available with flux protection construction.



Ordering Information

Classification	Contact Form	Model
#250 tab terminals/PCB coil terminals	SPST-NO	G4A-1A-E
PCB terminals/PCB coil terminals		G4A-1A-PE

Note: When ordering, add the rated coil voltage to the model number.

Example: G4A-1A-E 12 VDC
└───┘ Rated coil voltage

Model Number Legend

G4A-□□-□□ □ VDC
 1 2 3 4 5

- | | |
|--|---|
| <p>1. Number of Poles
1: 1 pole</p> <p>2. Contact Form
A: SPST-NO</p> <p>3. Terminals
None: #250 tab/PCB coil terminals
P: Straight PCB/PCB terminals</p> | <p>4. Special Function
E: For long endurance</p> <p>5. Rated Coil Voltage
5, 12, 24 VDC</p> |
|--|---|

Specifications

■ Coil Rating

Rated voltage	5 VDC	12 VDC	24 VDC
Rated current	180 mA	75 mA	37.5 mA
Coil resistance	27.8Ω	160Ω	640Ω
Coil inductance (ref. value)	Armature OFF	0.8 H	3.5 H
	Armature ON	1.1 H	4.8 H
Must operate voltage	70% of rated voltage max.		
Must release voltage	10% of rated voltage min.		
Max. permissible voltage	160% of rated voltage at (23°)		
Power consumption	Approx. 0.9 W		

- Note:**
1. The rated current and coil resistance are measured at a coil temperature of 23°C with a tolerance of ±10%.
 2. Operating characteristics are measured at a coil temperature of 23°C.
 3. Max. permissible voltage refers to the maximum value in a varying range of operating power voltage, not a continuous voltage.

■ Contact Ratings

Rated load	20 A at 250 VAC
Rated carry current	20 A
Max. switching voltage	250 VAC
Max. switching current	20 A
Max. switching power	5,000 VA
Failure rate (ref. value)	100 mA at 5 VDC

Note: P level: $\lambda_{60} = 0.1 \times 10^{-6}$ /operation (with an operating frequency of 120 operations/min).

■ Endurance

with Motor Load

Load conditions	Switching frequency	Electrical endurance
250 VAC: Inrush current: 80 A, 0.3 s ($\cos\theta = 0.7$) Break current: 20 A ($\cos\theta = 0.9$)	ON: 1.5 s OFF: 1.5 s	200,000 operations

With Overload

Load conditions	Switching frequency	Electrical endurance
250 VAC: Inrush current: 80 A ($\cos\theta = 0.7$) Break current: 80 A ($\cos\theta = 0.7$)	ON: 1.5 s OFF: 99 s	1,500 operations

With Inverter Load

Load conditions	Switching frequency	Electrical endurance
100 VAC: Inrush current: 200 A (0-P) Break current: 20 A	ON: 3 s OFF: 5 s	30,000 operations

■ Characteristics

Contact resistance	100 m Ω max.
Operate time	20 ms max.
Release time	10 ms max.
Max. Operating Frequency	Mechanical: 18,000 operations/hr
Insulation resistance	1000 M Ω max. (at 500 VDC)
Insulation resistance	100 M Ω max. (at 500 VDC)
Dielectric strength	4,500 VAC 50/60 Hz for 1 min between coil and contacts 1,000 VAC 50/60 Hz for 1 min between contacts of same polarity
Shock resistance	Destruction: 1,000 m/s ² Malfunction: 200 m/s ²
Vibration resistance	Destruction: 10 to 55 to 10 Hz, 0.75-mm single amplitude (1.5-mm double amplitude) Malfunction: 10 to 55 to 10 Hz, 0.75-mm single amplitude (1.5-mm double amplitude)
Endurance	Mechanical: 2,000,000 operations min. (at 18,000 operations/hr) Motor load: 100,000 operations min. (ON/OFF: 1.5 s) Inverter load: 30,000 operations min. (ON: 3 s, OFF: 5 s)
Ambient temperature	Operating: -20°C to 60°C (with no icing)
Ambient humidity	Operating: 5% to 85%
Weight	Approx. 25 g

Note: The data shown above are initial values.

DIN EN 61810-1/EN 60255-23 (VDE Reg. No. 6673)

Model	Coil ratings	Contact ratings
G4A-1A	5 to 48 VDC	20A, 250VAC

Engineering Data

Maximum Switching Power

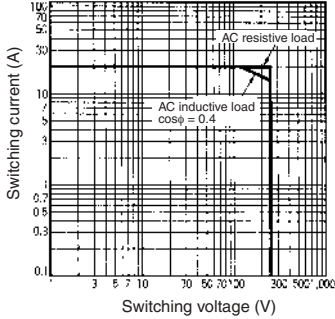

Endurance

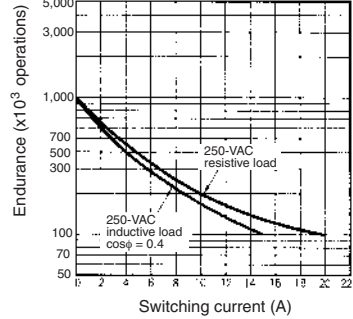

Dimensions

Note: All units are in millimeters unless otherwise indicated; dimensions shown in parentheses are in inches.

G4A-1A-E

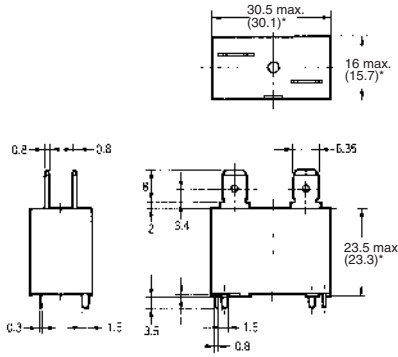
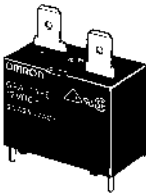

*Average value

Mounting Holes (Bottom View)

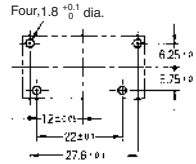

Terminal Arrangement / Internal Connections (Top View) (Bottom View)

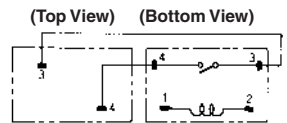

Tab Terminal PCB Terminal

G4A-1A-PE

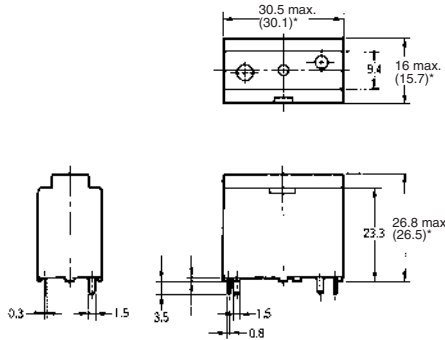
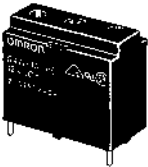

*Average value

Mounting Holes (Bottom View)

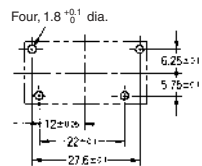

Terminal Arrangement / Internal Connections (Bottom View)

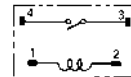

Precautions

Mounting

When mounting two or more relays side by side, provide a minimum space of 3 mm between relays.

Terminal Connection

The terminals fit FASTON receptacle 250 and are suitable for positive-lock mounting. Do not apply excessive force on the terminals when mounting or dismounting the relay. The following positive-lock connectors made by AMP are recommended.

Type	Receptacle terminals	Positive housing
#250 terminals (width: 6.35 mm)	AMP 170333-1 (170327-1) AMP 170334-1 (170328-1) AMP 170335-1 (170329-1)	AMP 172076-1 natural color AMP 172076-4 yellow AMP 172076-5 green AMP 172076-6 blue

Note: The numbers shown in parentheses are for air-feeding.

DC Power Relays Capable of Interrupting High-voltage, High-current Loads

- A compact relay (73 x 36 x 67.2 mm (L x W x H)) capable of switching 400-V 60-A/100-A DC loads. (Capable of interrupting 600 A at 300 VDC max.)
- The switching section and driving section are gas-injected and hermetically sealed, allowing these compact relays to interrupt high-capacity loads. The sealed construction also requires no arc space, saves space, and helps ensure safe applications.
- Downsizing and optimum design allow no restrictions on the mounting direction.
- Terminal Cover and DIN Track Adapters are also available for industrial applications.
- UL/CSA approval pending.



Model Number Structure

Model Number Legend

G9EA-□-□-□-□
 1 2 3 4

1. Number of Poles

1: 1 pole

2. Contact Form

Blank: SPST-NO

3. Coil Terminals

B: M3.5 screw terminals

Blank: Lead Wire Output

4. Special Functions

CA: High-current conduction (100 A)

Note: Power-saving Models (with auxiliary contacts function) are scheduled to be added to the lineup as special function models.

Specifications

List of Models

Models	Terminals		Contact form	Rated coil voltage	Model
	Coil terminals	Contact terminals			
Switching / current conduction models	Screw terminals	Screw terminals	SPST-NO	12 VDC	G9EA-1-B
	Lead wires			24 VDC	G9EA-1
High-current conduction models	Screw terminals	60 VDC		G9EA-1-B-CA	
	Lead wires	100 VDC		G9EA-1-CA	

Note: 1. Relays come with two M5 screws for the main terminals (contacts).

2. Relays with coil terminals and screw terminals come with two M3.5 screws.

■ Ratings

Coil

Rated voltage	Rated current	Coil resistance	Must-operate voltage	Must-release voltage	Max. Voltage (see note 3)	Power consumption
12 VDC	417 mA	28.8 Ω	75% max. of rated voltage	8% min. of rated voltage	130% of rated voltage	Approx. 5 W
24 VDC	208 mA	115.2 Ω				
48 VDC	102 mA	469.3 Ω				
60 VDC	86.2 mA	695.7 Ω				Approx. 5.2 W
100 VDC	53.6 mA	1,864 Ω				Approx. 5.4 W

Note: 1. The figures for the rated current and coil resistance are for a coil temperature of 23°C and have a tolerance of ±10%.

2. The figures for the operating characteristics are for a coil temperature of 23°C.

3. The figure for the maximum voltage is the maximum voltage that can be applied to the relay coil for period of 10 minutes at an ambient temperature of 23°C. It does not apply to continuous operation.

Contacts

Item	Rated current	
	G9EA-1(-B)	G9EA-1(-B)-CA
Rated load	60 A at 400 VDC, 100 A at 120 VDC	30 A at 400 VDC
Rated carry current	60 A	100 A
Maximum switching voltage	400 V	400 V
Maximum switching current	100 A	30 A

■ Characteristics

Item		G9EA-1(-B)	G9EA-1(-B)-CA
Contact resistance (see note 2)		30 mΩ max. (0.6 mΩ typical)	10 mΩ max. (0.3 mΩ typical)
Contact voltage drop		0.1 V max. (for a carry current of 60 A)	0.1 V max. (for a carry current of 100 A)
Operate time		50 ms max.	
Release time		30 ms max.	
Insulation resistance (see note 3.)	Between coil & contacts	1,000 MΩ min.	
	Between contacts of the same polarity	1,000 MΩ min.	
Dielectric strength	Between coil & contacts	2,500 VAC, 1 min	
	Between contacts of the same polarity	2,500 VAC, 1 min	
Impulse withstand voltage (See note 4.)		4,500 V	
Vibration resistance	Destruction	10 to 55 to 10 Hz, 0.75-mm single amplitude (Acceleration: 2.94 to 88.9 m/s ²)	
	Malfunction	10 to 55 to 10 Hz, 0.75-mm single amplitude (Acceleration: 2.94 to 88.9 m/s ²)	
Shock resistance	Destruction	490 m/s ²	
	Malfunction	196 m/s ²	
Mechanical endurance (See note 5.)		200,000 ops. min.	
Electrical endurance (See note 6.)		120 VDC, 100 A, 3,000 ops. min.	400 VDC, 30 A, 1,000 ops. min.
		400 VDC, 60 A, 3,000 ops. min.	120 VDC, 30 A, 2,500 ops. min.
		400 VDC, 30 A, 30,000 ops. min.	–
Short-time carry current		100 A (10 min)	150 A (10 min)
Maximum interruption current		600 A at 300 VDC (5 times)	–
Overload interruption		180 A at 400 VDC (100 times min.)	100 A at 120 VDC (150 times min.)
Reverse polarity interruption		-60 A at 200 VDC (1,000 times min.)	–
Ambient operating temperature		-40 to 70°C (with no icing or condensation)	
Ambient operating humidity		5% to 85%	
Weight Approx.		310 g	

Note: 1. The above values are initial values at an ambient temperature of 23°C unless otherwise specified.

2. The contact resistance was measured with 1 A at 5 VDC using the voltage drop method.

3. The insulation resistance was measured with a 500-VDC megohmmeter.

4. The impulse withstand voltage was measured with a JEC-212 (1981) standard impulse voltage waveform (1.2 x 50 μs).

5. The mechanical endurance was measured at a switching frequency of 3,600 operations/hr.

6. The electrical endurance was measured at a switching frequency of 60 operations/hr.

■ G9EA-1(-B) Switching/Current Conduction Models

Maximum Switching Capacity

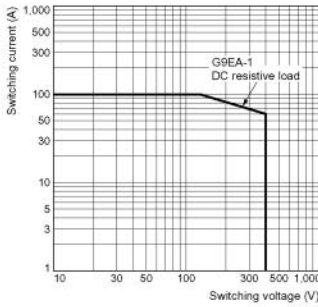

Electrical Endurance (Switching Performance)

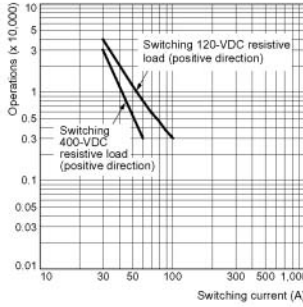

Electrical Endurance (Interruption Performance)

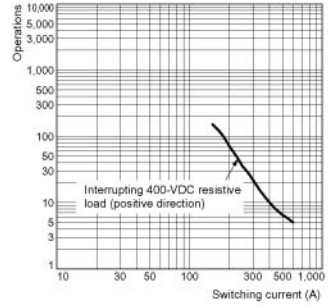

Carry Current vs Energizing Time

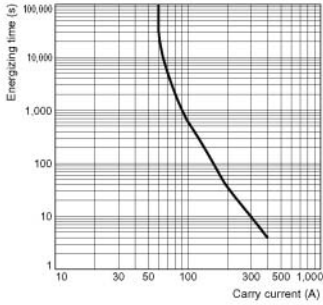

■ G9EA-1(-B)-CA High-current Conduction Models

Maximum Switching Capacity

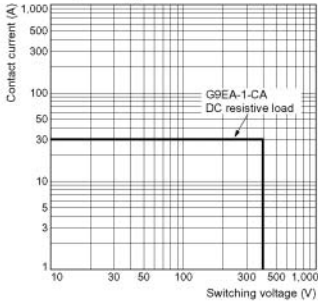

Electrical Endurance (Switching Performance)

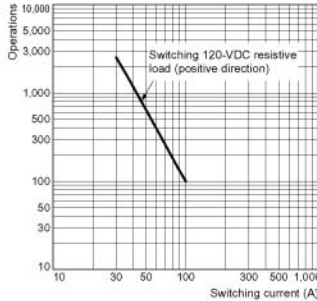

Carry Current vs Energizing Time

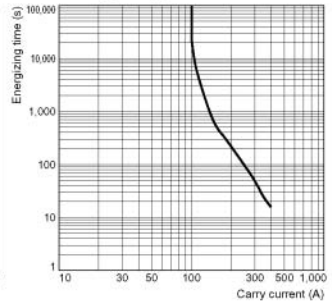

■ All G9EA-1 Models

Must-operate Voltage and Must-release Voltage Distributions

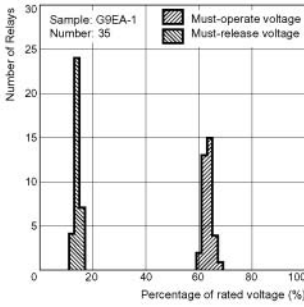

Time Characteristic Distributions

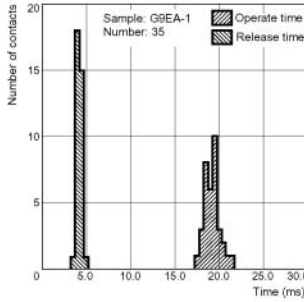

Vibration Malfunction

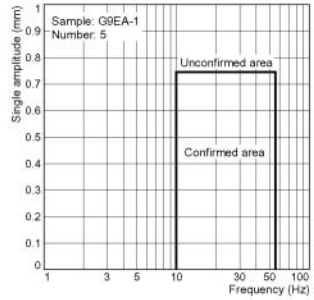

Vibration Resistance

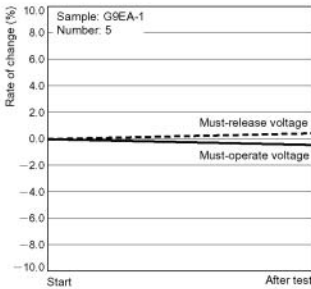

Start After test
Characteristics were measured after applying vibration at a frequency of 10 to 55 Hz (single amplitude of 0.75 mm) to the test piece (not energized) for 2 hours each in 3 directions. The percentage rate of change is the average value for all of the samples

Shock Malfunction

Unit: m/s²
Sample: G9EA-1
Number: 5

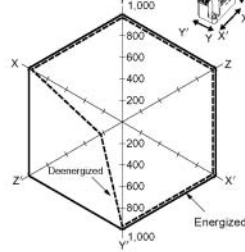

The value at which malfunction occurred was measured after applying shock to the test piece 3 times each in 6 directions along 3 axes.

Shock Resistance

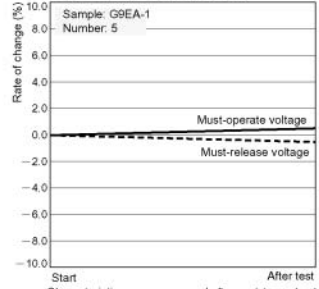

Start After test
Characteristics were measured after applying a shock of 490 m/s² to the test piece 3 times each in 6 directions along 3 axes. The percentage rate of change is the average value for all of the samples.

Dimensions

Note: All units are in millimeters unless otherwise indicated.

■ Models with Screw Terminals

G9EA-1-B(-CA)

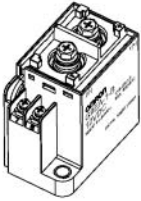

Dimension (mm)	Tolerance (mm)
10 or lower	±0.3
10 to 50	±0.5
50 or higher	±1

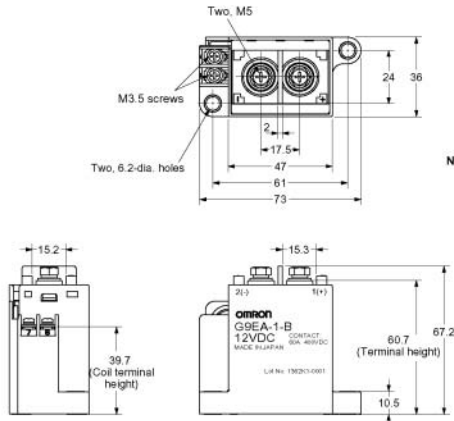

Terminal Arrangement/
Internal Connections
(TOP VIEW)

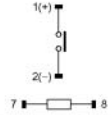

Note: Be sure to connect terminals with the correct polarity. Coils do not have polarity.

Mounting Hole Dimensions
(TOP VIEW)

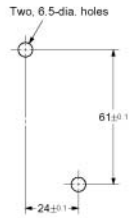

■ Models with Lead Wires

G9EA-1(-CA)

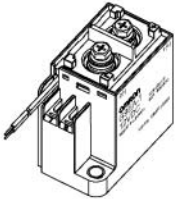

Dimension (mm)	Tolerance (mm)
10 or lower	±0.3
10 to 50	±0.5
50 or higher	±1

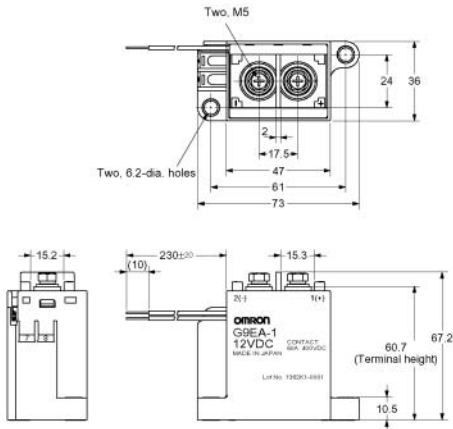

Terminal Arrangement/
Internal Connections
(TOP VIEW)

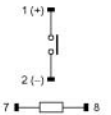

Note: Be sure to connect terminals with the correct polarity. Coils do not have polarity.

Mounting Hole Dimensions
(TOP VIEW)



Options

■ Terminal Cover

P9EA-C

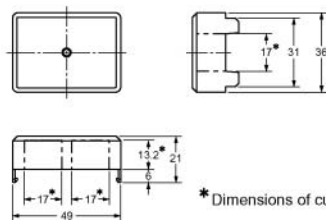

Dimension (mm)	Tolerance (mm)
10 or lower	±0.3
10 to 50	±0.5
50 or higher	±1

* Dimensions of cutouts for wiring.

■ DIN Track Adaptor

P9EA-D

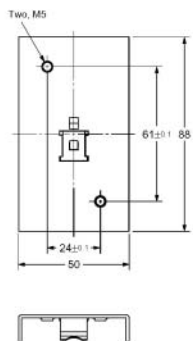

Dimension (mm)	Tolerance (mm)
10 or lower	±0.3
10 to 50	±0.5
50 or higher	±1

DC Power Relays Capable of Interrupting High-voltage, High-current Loads

- A compact relay (98 x 44 x 86.7 mm (L x W x H)) capable of switching 400V, 200 A DC loads. (Capable of interrupting 1,000 A at 400 VDC max.)
- The switching section and driving section are gas-injected and hermetically sealed, allowing these compact relays to interrupt high-capacity loads. The sealed construction also requires no arc space, saves space, and helps ensure safe applications.
- Downsizing and optimum design allow no restrictions on the mounting direction.
- Terminal Cover is also available for industrial applications.
- UL/CSA approval pending.



Model Number Structure

Model Number Legend

G9EC-□-□-□-□
 1 2 3 4

- 1. Number of Poles**
1: 1 pole
- 2. Contact Form**
Blank: SPST-NO

- 3. Coil Terminals**
B: M3.5 screw terminals (standard)
Blank: Lead wire output
- 4. Special Functions**

Note: Power-saving Models (with auxiliary contacts function) are scheduled to be added to the line-up as special function models.

Specifications

List of Models

Models	Terminals		Contact form	Rated coil voltage	Model
	Coil terminals	Contact terminals			
Switching / current conduction models	Screw terminals	Screw terminals	SPST-NO	12 VDC 24 VDC 48 VDC 60 VDC 100 VDC	G9EC-1-B
	Lead wires				G9EC-1

- Note:** 1. Relays come with two M8 nuts for the main terminals (contacts).
 2. Relays with coil terminals and screw terminals come with two M3.5 screws.

■ Ratings

Coil

Rated voltage	Rated current	Coil resistance	Must-operate voltage	Must-release voltage	Max. Voltage (see note 3)	Power consumption
12 VDC	938 mA	12.8 Ω	75% max. of rated voltage	8% min. of rated voltage	110% of rated voltage	Approx. 11 W
24 VDC	469 mA	51.2 Ω				
48 VDC	234 mA	204.8 Ω				
60 VDC	188 mA	320.0 Ω				
100 VDC	113 mA	888.9 Ω				

Note: 1. The figures for the rated current and coil resistance are for a coil temperature of 23°C and have a tolerance of $\pm 10\%$.

2. The figures for the operating characteristics are for a coil temperature of 23°C.

3. The figure for the maximum voltage is the maximum voltage that can be applied to the relay coil for period of 10 minutes at an ambient temperature of 23°C. It does not apply to continuous operation.

Contacts

Item	Rated current
	G9EC-1(-B)
Rated load	200 A at 400 VDC
Rated carry current	200 A
Maximum switching voltage	400 V
Maximum switching current	200 A

■ Characteristics

Item		G9EC-1(-B)
Contact resistance (see note 2)		30 mΩ max. (0.2 mΩ typical)
Contact voltage drop		0.1 V max. (for a carry current of 200 A)
Operate time		50 ms max.
Release time		30 ms max.
Insulation resistance (see note 3.)	Between coil & contacts	1,000 MΩ min.
	Between contacts of the same polarity	1,000 MΩ min.
Dielectric strength	Between coil & contacts	2,500 VAC, 1 min
	Between contacts of the same polarity	2,500 VAC, 1 min
Impulse withstand voltage (See note 4.)		4,500 V
Vibration resistance	Destruction	10 to 55 to 10 Hz, 0.75-mm single amplitude (Acceleration: 2.94 to 88.9 m/s ²)
	Malfunction	10 to 55 to 10 Hz, 0.75-mm single amplitude (Acceleration: 2.94 to 88.9 m/s ²)
Shock resistance	Destruction	490 m/s ²
	Malfunction	196 m/s ²
Mechanical endurance (See note 5.)		200,000 ops. min.
Electrical endurance (resistive load) (See note 6.)		400 VDC, 200 A, 3,000 ops. min.
Short-time carry current		300 A (15 min)
Maximum interruption current		1,000 A at 400 VDC (10 times)
Overload interruption		700 A at 400 VDC (40 times min.)
Reverse polarity interruption		-200 A at 200 VDC (1,000 times min.)
Ambient operating temperature		-40 to 50°C (with no icing or condensation)
Ambient operating humidity		5% to 85%
Weight Approx.		570 g

Note: 1. The above values are initial values at an ambient temperature of 23°C unless otherwise specified.

2. The contact resistance was measured with 1 A at 5 VDC using the voltage drop method.

3. The insulation resistance was measured with a 500 VDC megohmmeter.

4. The impulse withstand voltage was measured with a JEC-212 (1981) standard impulse voltage waveform (1.2 x 50 μs).

5. The mechanical endurance was measured at a switching frequency of 3,600 operations/hr.

6. The electrical endurance was measured at a switching frequency of 60 operations/hr.

■ G9EC-1 Switching / Current Conduction Models

Maximum Switching Capacity

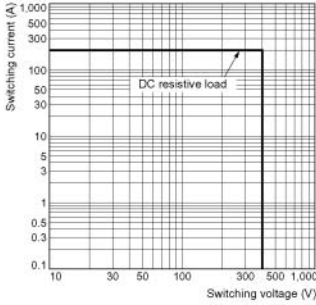

Electrical Endurance (Switching Performance)

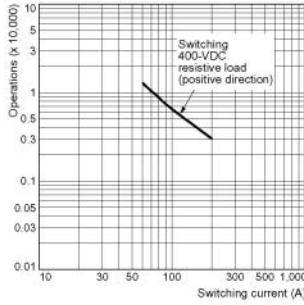

Electrical Endurance (Interruption Performance)

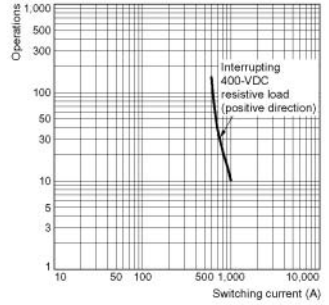

Carry Current vs Energizing Time

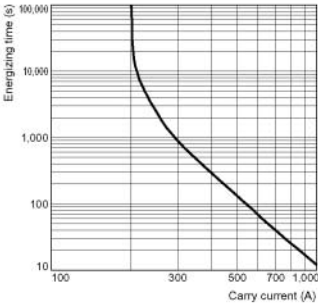

Must-operate Voltage and Must-release Voltage Distributions

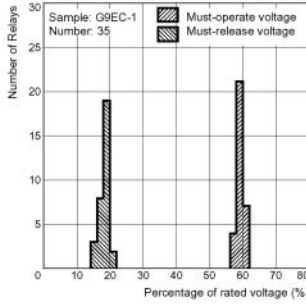

Time Characteristic Distributions

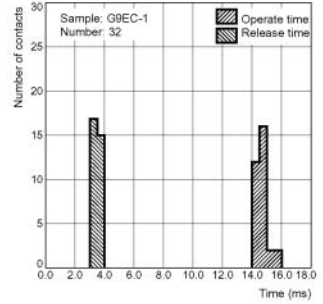

■ G9EC-1 Switching / Current Conduction Models

Vibration Malfunction

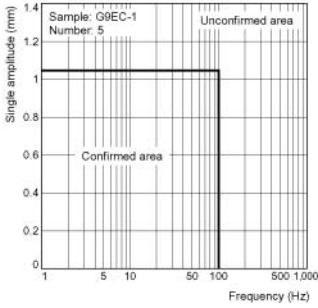

Vibration Resistance

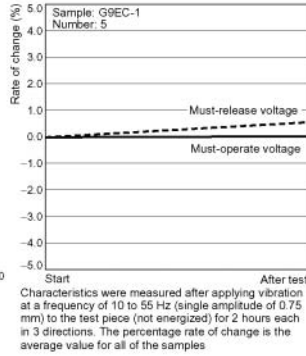

Shock Malfunction

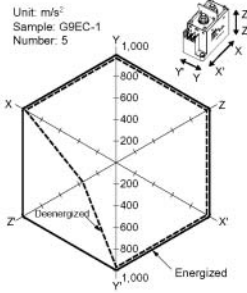

The value at which malfunction occurred was measured after applying shock to the test piece 3 times each in 6 directions along 3 axes.

Shock Resistance

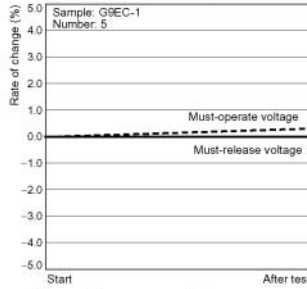

Dimensions

Note: All units are in millimeters unless otherwise indicated.

Models with Screw Threads

G9EC-1-B

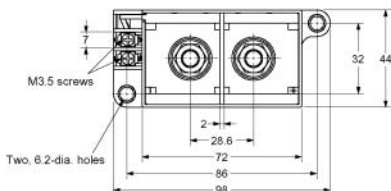
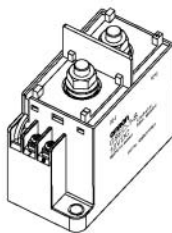

Terminal Arrangement/
Internal Connections
(TOP VIEW)

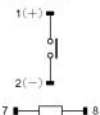

Note: Be sure to connect terminals with the correct polarity. Coils do not have polarity.

Mounting Hole Dimensions
(TOP VIEW)

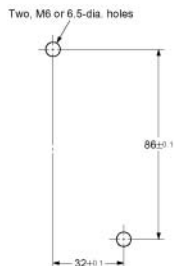

Dimension (mm)	Tolerance (mm)
10 or lower	±0.3
10 to 50	±0.5
50 or higher	±1

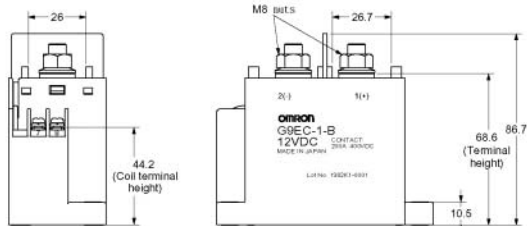

Models with Lead Wires

G9EC-1

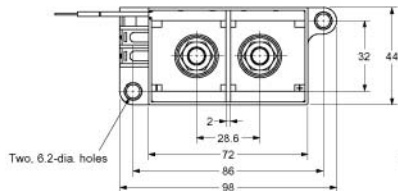
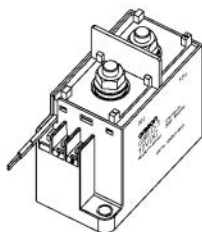

Terminal Arrangement/
Internal Connections
(TOP VIEW)

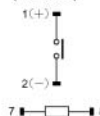

Note: Be sure to connect terminals with the correct polarity. Coils do not have polarity.

Mounting Hole Dimensions
(TOP VIEW)

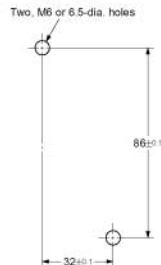

Dimension (mm)	Tolerance (mm)
10 or lower	±0.3
10 to 50	±0.5
50 or higher	±1

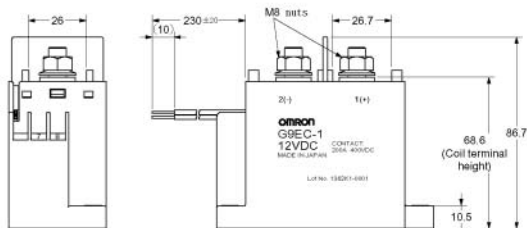

Options

Terminal Cover

P9EC-C

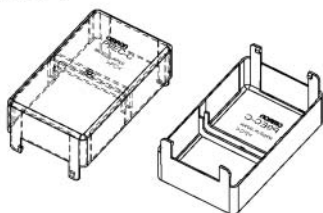

• Dimensions of cutout for wiring.

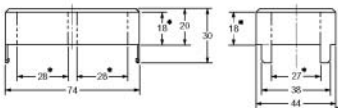

Dimension (mm)	Tolerance (mm)
10 or lower	±0.3
10 to 50	±0.5
50 or higher	±1

Precautions

WARNING



Take measures to prevent contact with charged parts when using the Relay for high voltages.

■ Correct Use

Refer to the relevant catalog for common precautions.

- Be sure to tighten all screws to the appropriate torque given below. Loose screws may result in burning due to abnormal heat generation during energization.
 - M8 screws: 8.82 to 9.80 N·m
 - M6 screws: 3.92 to 4.90 N·m
 - M5 screws: 1.57 to 2.35 N·m
 - M4 screws: 0.98 to 1.37 N·m
 - M3.5 screws: 0.75 to 1.18 N·m
- The G9EA and G9EC Relays' contacts have polarity. Be sure to perform connections with the correct polarity. If the contacts are connected with the reverse polarity, the switching characteristics specified in this document cannot be assured.
- Do not drop or disassemble this Relay. Not only may the Relay fail to meet the performance specifications, it may also result in damage, electric shock, or burning.
- Do not use these Relays in strong magnetic fields of 800 A/m or higher (e.g., near transformers or magnets). The arc discharge that occurs during switching may be bent by the magnetic field, resulting in flashover or insulation faults.
- This Relay is a device for switching high DC voltages. If it is used for voltages exceeding the specified range, it may not be possible to interrupt the load and burning may result. In order to prevent fire spreading, use a configuration in which the current load can be interrupted in the event of emergencies.

In order to ensure safety of the system, replace the Relay on a regular basis.
- If the Relay is used for no-load switching, the contact resistance may increase and so confirm correct operation under the actual operating conditions.
- These Relays contain pressurized gas. Even in applications with low switching frequencies, the ambient temperature and heat caused by arc discharge in the contacts may allow permeation of the sealed gas, resulting in arc interruption failure.

In order to ensure safety of the system, replace Relays on a regular basis.
- Do not use or store the Relay in a vacuum. Doing so will accelerate deterioration of the sealing.
- With this Relay, if the rated voltage (or current) is continuously applied to the coil and contacts, and then turned OFF and immediately ON again, the coil temperature, and consequently the coil resistance, will be higher than usual. This means that the mustoperate voltage will also be higher than usual, exceeding the rated value ("hot start"). In this case, take the appropriate countermeasures, such as reducing the load current or restricting the energizing time or ambient operating temperature.

- The ripple percentage for DC relays can cause fluctuations in the must-operate voltage or humming. For this reason, reduce the ripple percentage in full-wave rectified power supply circuits by adding a smoothing capacitor. Ensure that the ripple percentage is less than 5%.
- Ensure that a voltage exceeding the specified maximum voltage is not continuously applied to the coil. Abnormal heating in the coil may shorten the lifetime of the insulation coating.
- Do not use the Relay at a switching voltage or current greater than the specified maximum values. Doing so may result in arc discharge interruption failure or burning due to abnormal heating in the contacts.
- The contact ratings are for resistive loads. The electrical endurance with inductive loads is inferior to that of resistive loads. Confirm correct operation under the actual operating conditions.
- Do not use the Relay in locations where water, solvents, chemicals, or oil may come in contact with the case or terminals. Doing so may result in deterioration of the case resin or abnormal heating due to corrosion or contamination of the terminals. Also, if electrolyte adheres to the output terminals, electrolysis may occur between the output terminals, resulting in corrosion of the terminals or wiring disconnections.
- Be sure to turn OFF the power and confirm that there is no residual voltage before replacing the Relay or performing wiring.
- The distance between crimp terminals or other conductive parts will be reduced and insulation properties will be lowered if wires are laid in the same direction from the contact terminals. Use insulating coverings, do not wire in the same direction, and take other measures as required to maintain insulation properties.
- Do not tighten the screws to a torque exceeding 11 N·m for the M8 screws and 5 N·m for the M5 screws.

Overtightening the contact terminals will reduce the switching performance and damage the product.

The coil's power consumption can be reduced by using in combination with a semiconductor circuit. Consult your OMRON representative for details.

Recommended Wire Size

Model	Size
G9EA-1(-B)	14 to 22 mm ²
G9EA-1(-B)-CA	22 to 38 mm ²
G9EC-1(-B)	38 to 60 mm ²
G9EB-1-B	Consult your OMRON representative

Note: Use flexible leads.

ALL DIMENSIONS SHOWN ARE IN MILLIMETERS.

To convert millimeters into inches, multiply by 0.03937. To convert grams into ounces, multiply by 0.03527.